

fischer[®]technik

Ergänzung zu den Grundkästen

Statik I

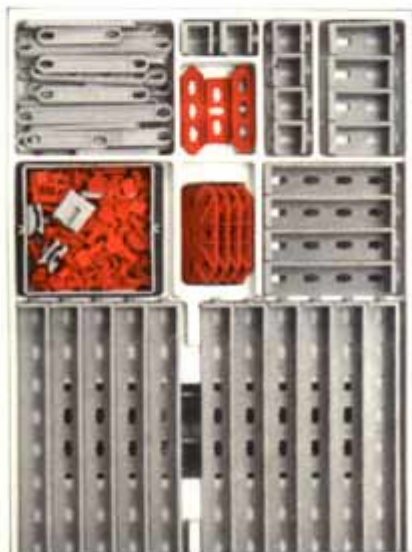

Zusammenbau der Einzelteile
This is how the parts fit together
Assemblage des pièces
Aan elkaar verbinden van de onderdelen



Zusammenbau der Einzelteile
This is how the parts fit together
Assemblage des pièces
Aan elkaar verbinden van de onderdelen



Zusammenbau der Einzelteile
This is how the parts fit together
Assemblage des pièces
Aan elkaar verbinden van de onderdelen

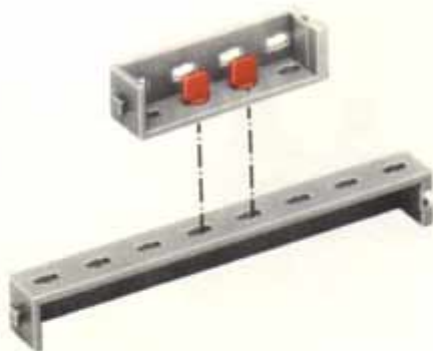

Zusammenbau der Einzelteile
This is how the parts fit together
Assemblage des pièces
Aan elkaar verbinden van de onderdelen

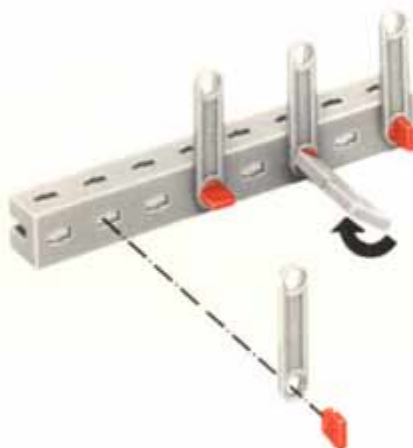

Zusammenbau der Einzelteile
This is how the parts fit together
Assemblage des pièces
Aan elkaar verbinden van de onderdelen



Zusammenbau der
Einzelteile
This is how the parts
fit together
Assemblage des
pièces
Aan elkaar verbinden
van de onderdelen

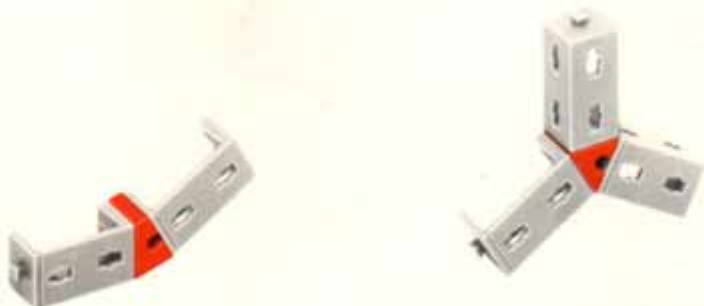
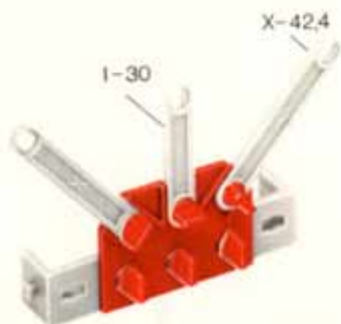

Zusammenbau der Einzelteile
This is how the parts fit together
Assemblage des pièces
Aan elkaar verbinden van de onderdelen



Zusammenbau der Einzelteile
This is how the parts fit together
Assemblage des pièces
Aan elkaar verbinden van de onderdelen



Zusammenbau der Einzelteile
This is how the parts fit together
Assemblage des pièces
Aan elkaar verbinden van de onderdelen

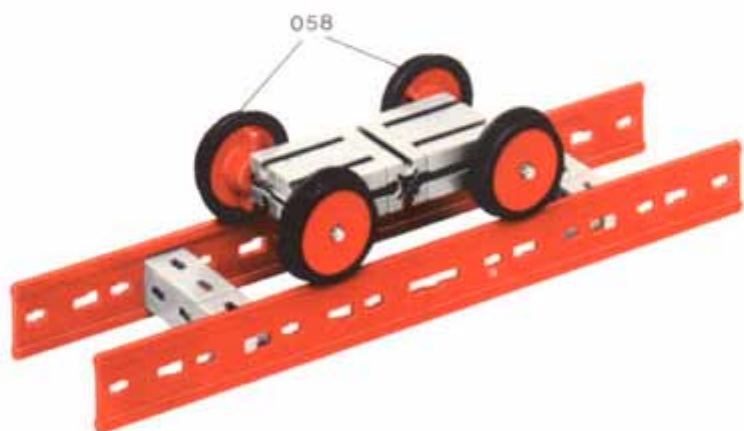
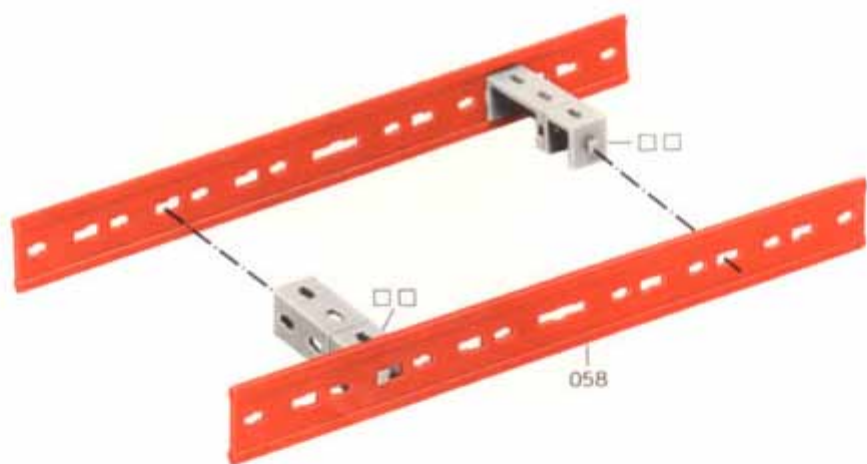

Zusammenbau der Einzelteile
This is how the parts fit together
Assemblage des pièces
Aan elkaar verbinden van de onderdelen

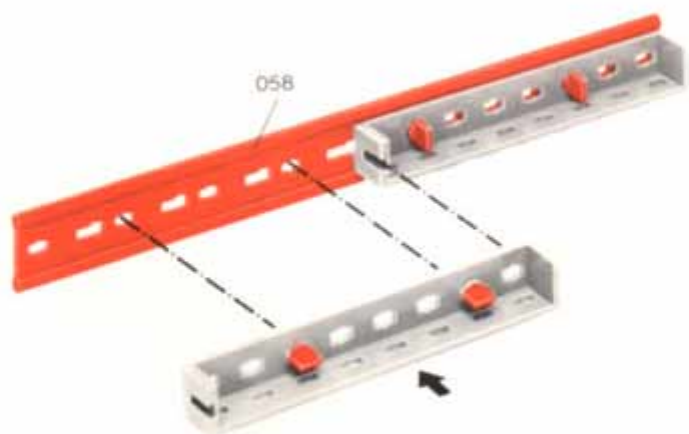
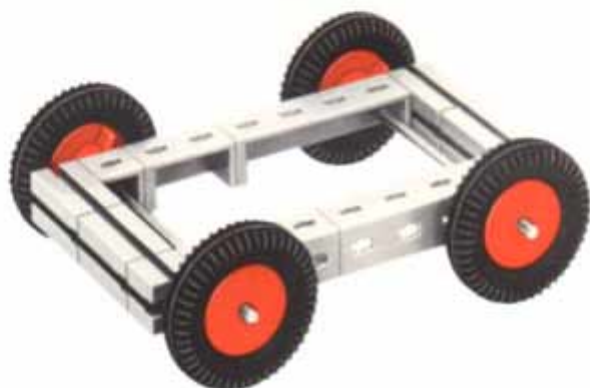

Statik 1 + 50

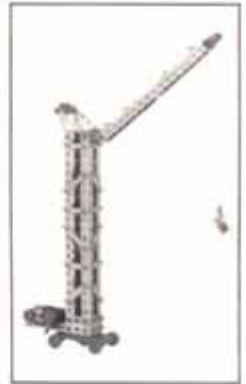
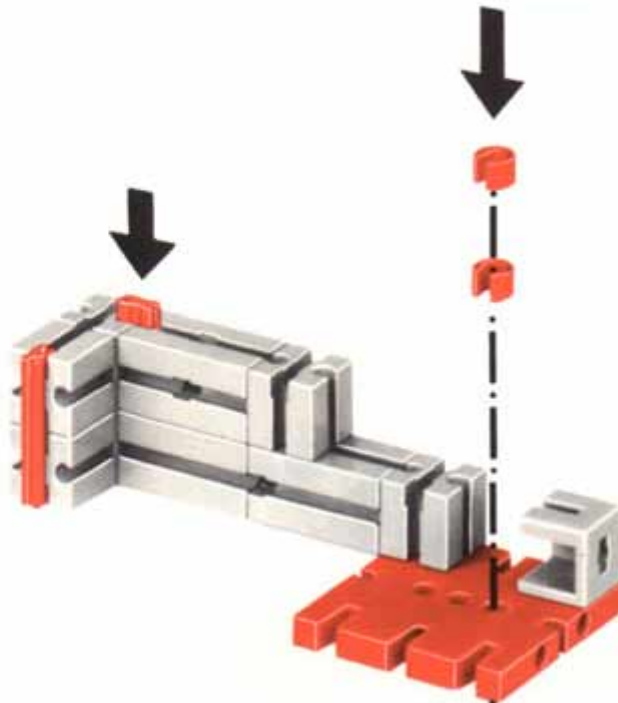

Baukran
Tower crane
Grue
Bouwkraan

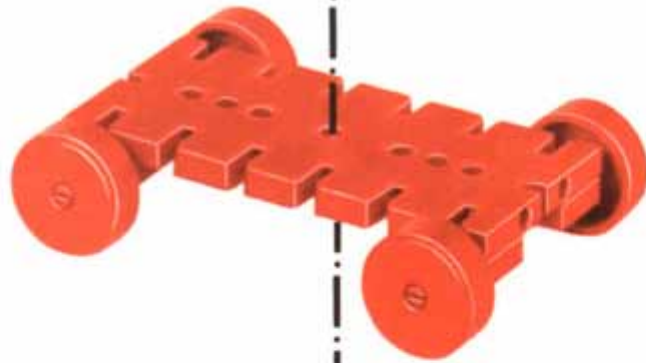

50



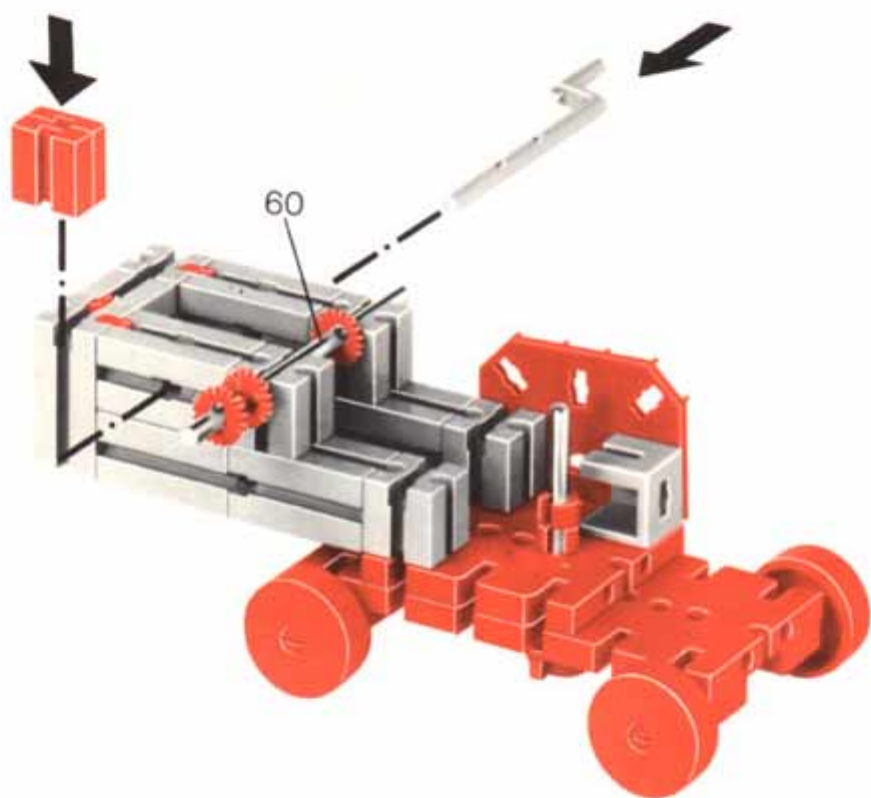
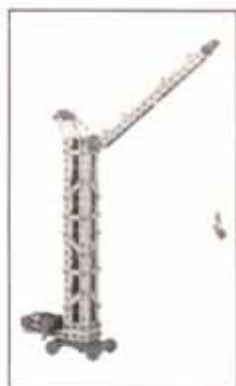

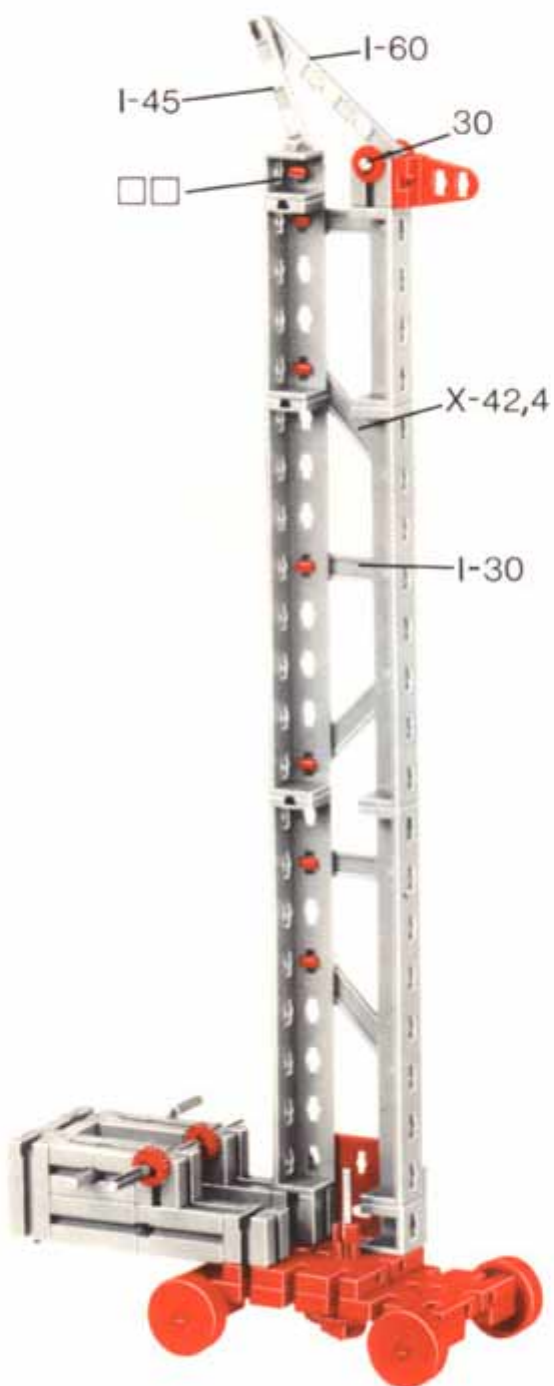

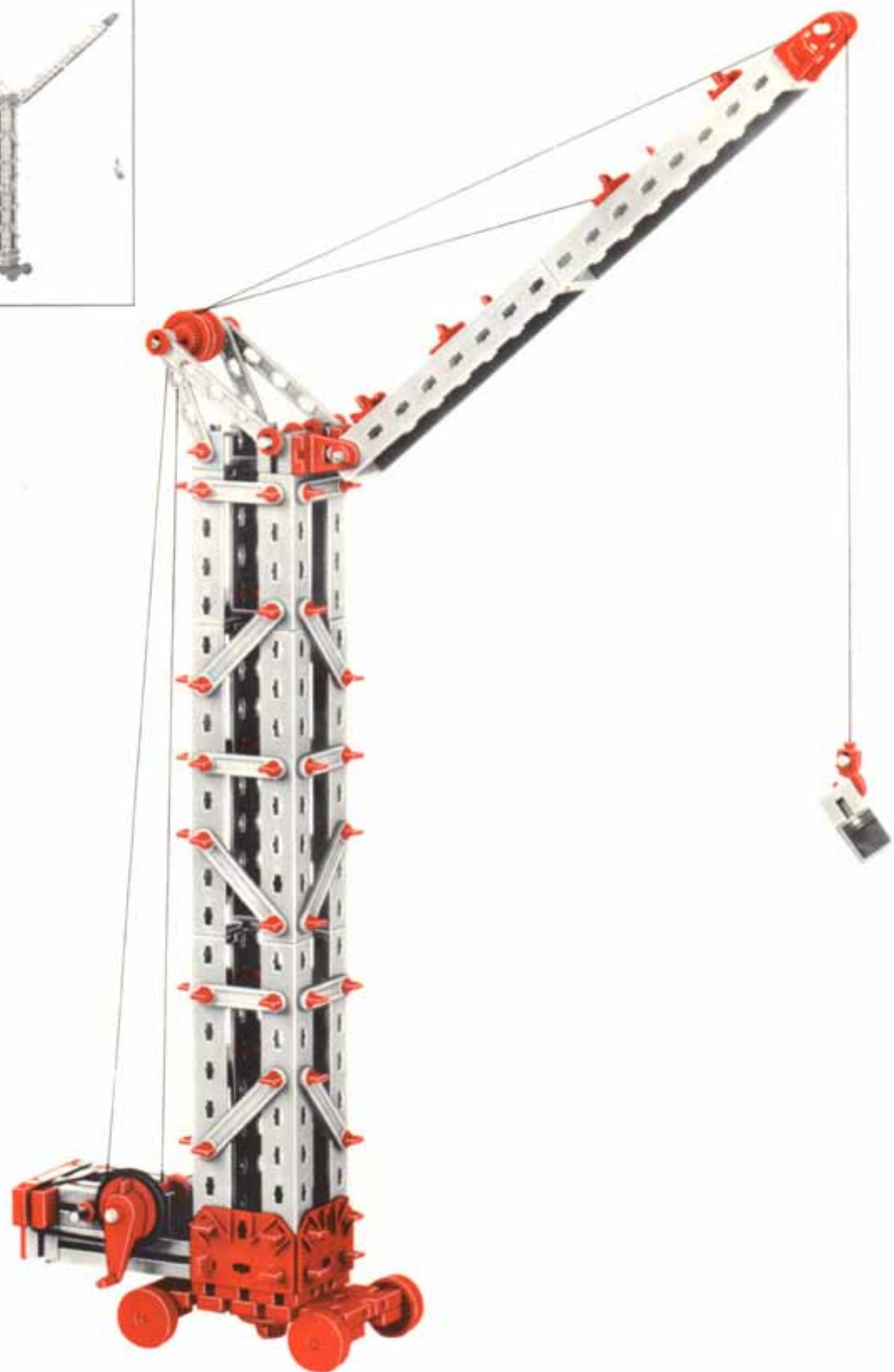

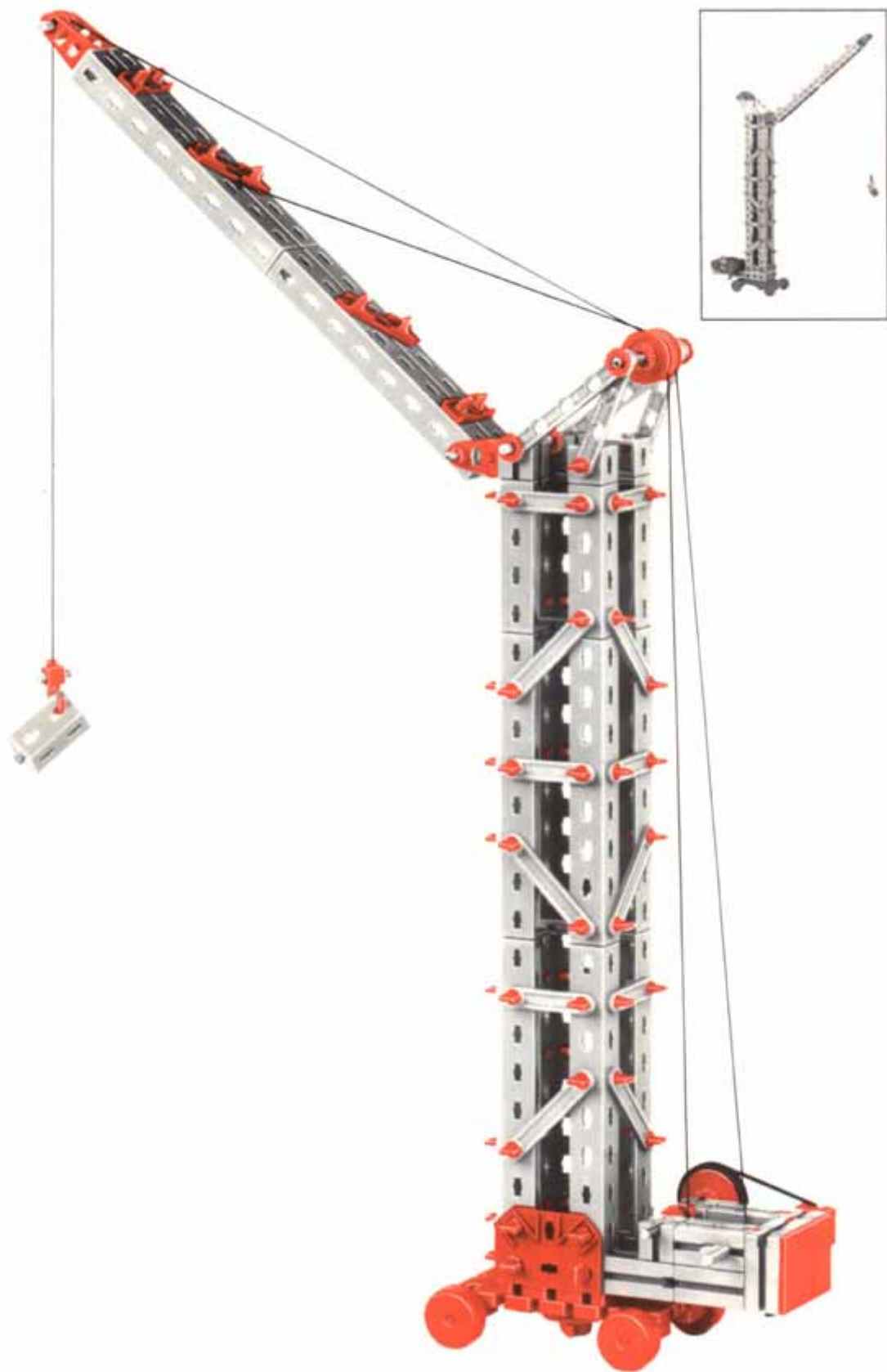

Statik 1 + 50



Aufzug
Lift
Monte-charge
Lift



Statik 1 + 50

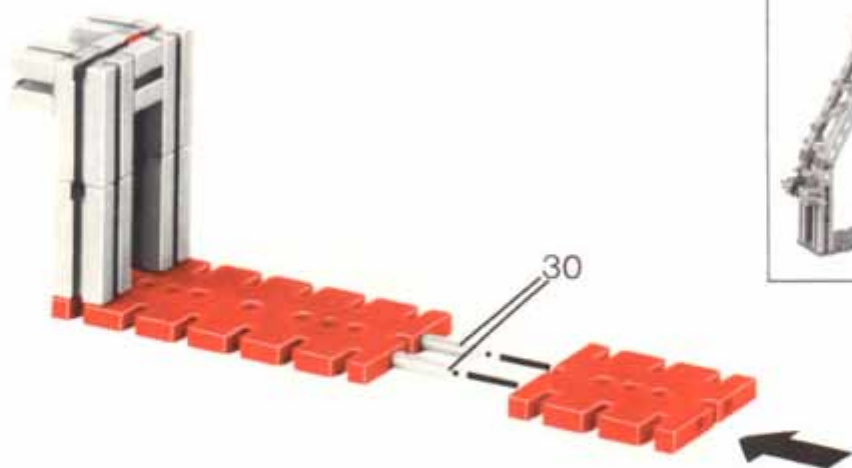

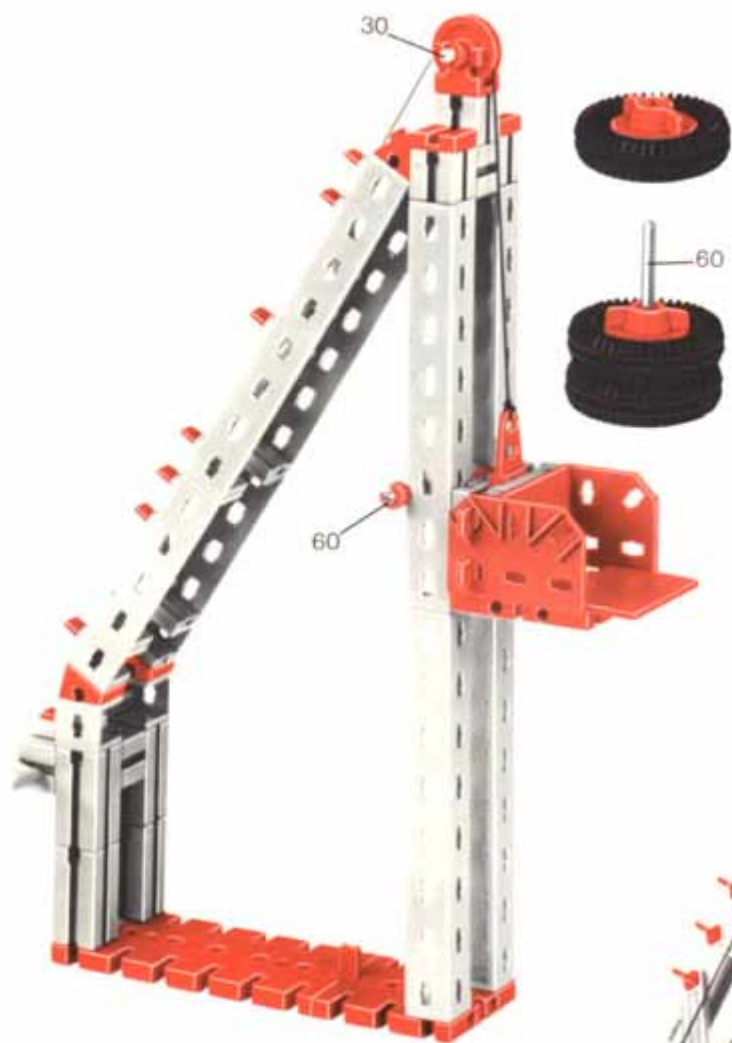

Statik 1 + 100



Sendeturm
A large broadcast
tower
Télécommunications
Zendertoren

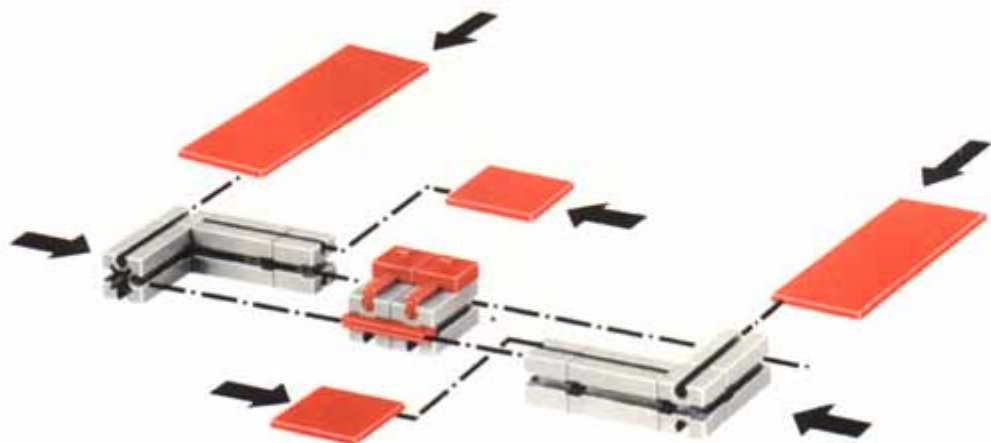
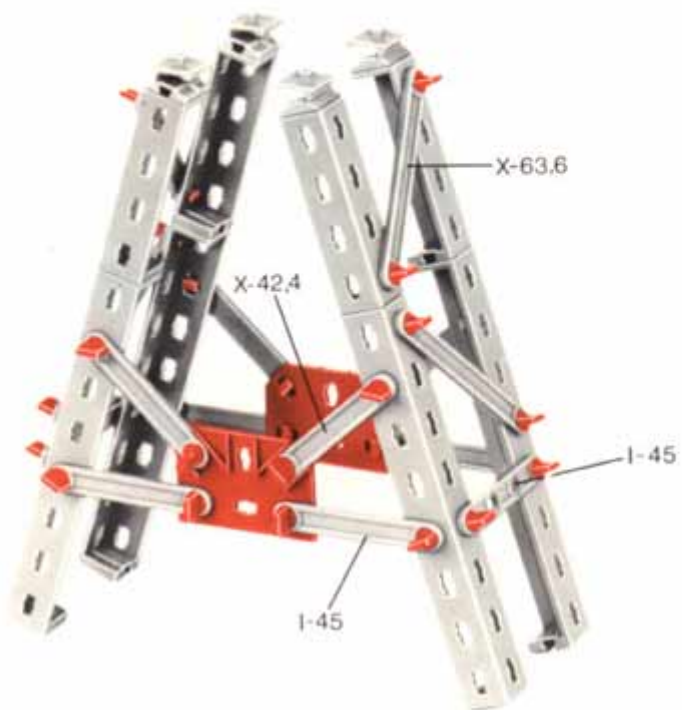



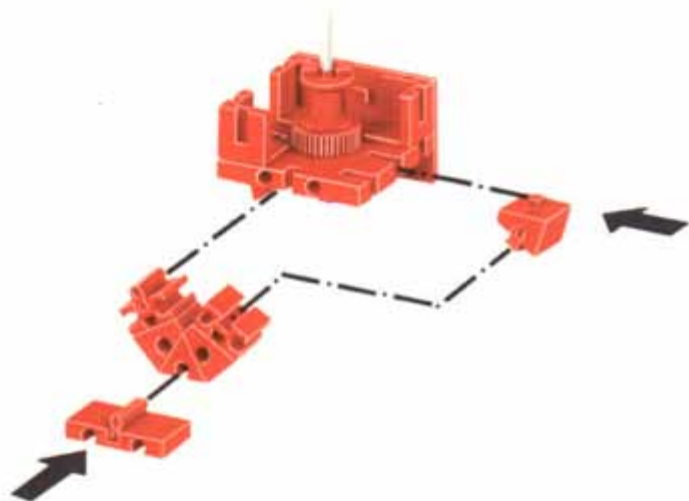

Statik 1 + 100



Kranwagen
Heavy duty mobile
crane
Grue mobile
Kraanwagen

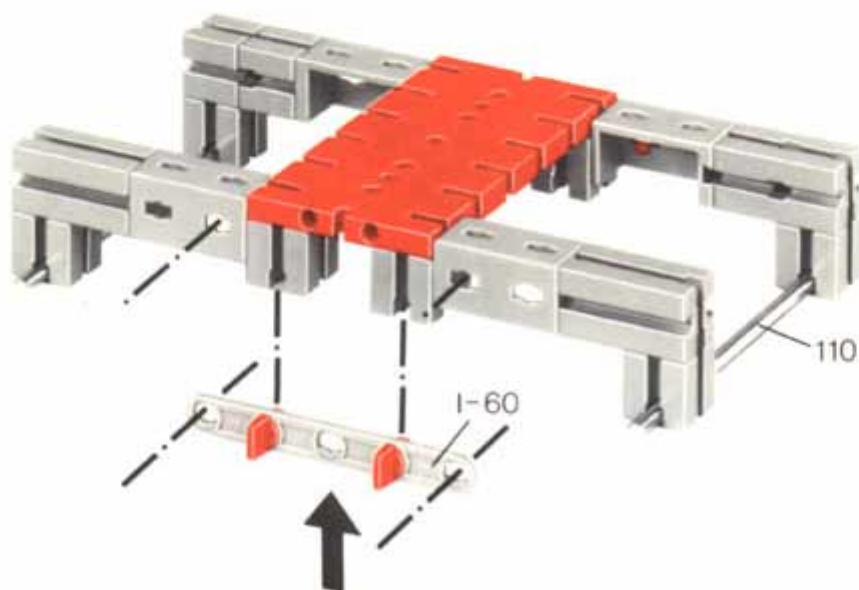

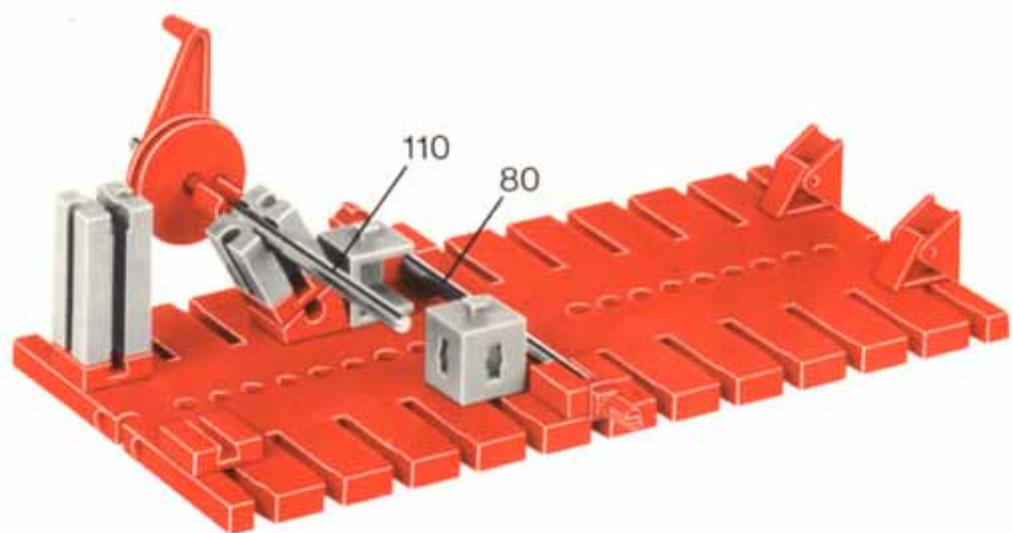

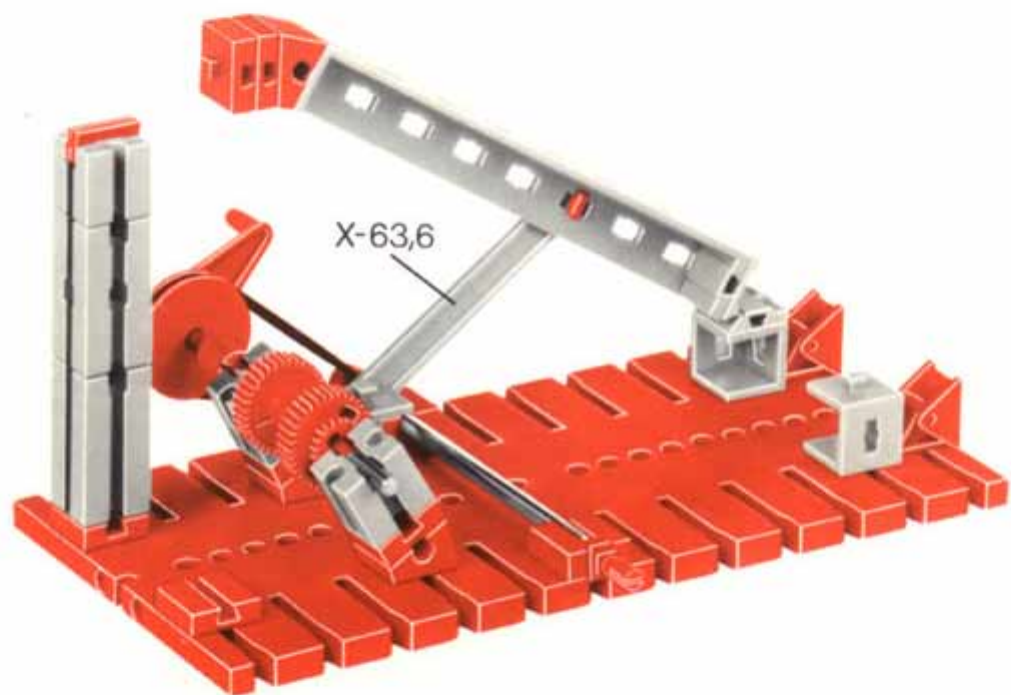





Statik 1 + 200



Abschleppwagen
Tow truck
Dépanneuse
Sleepwagen

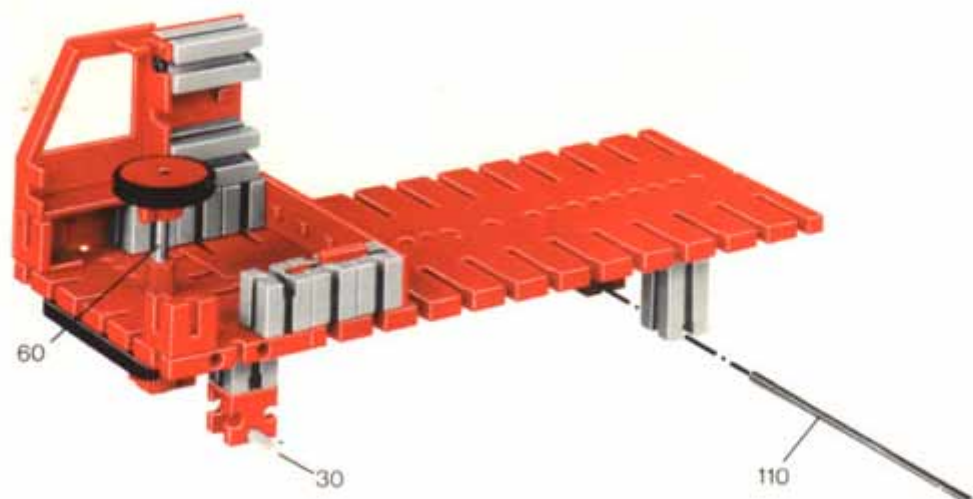
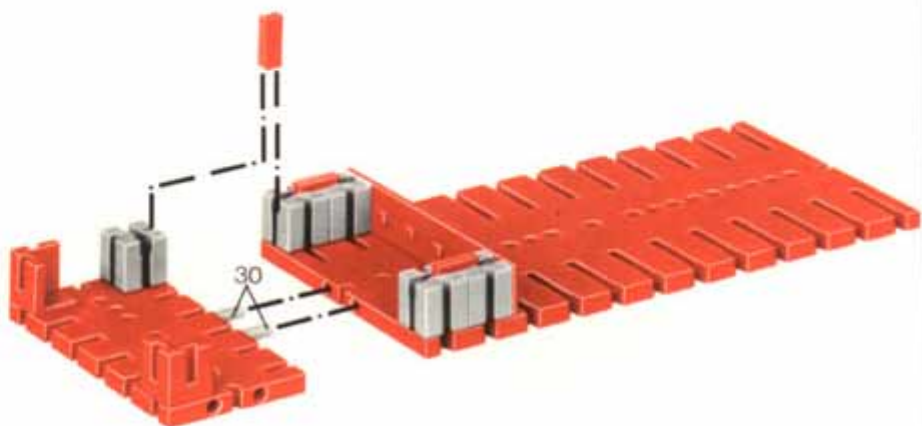

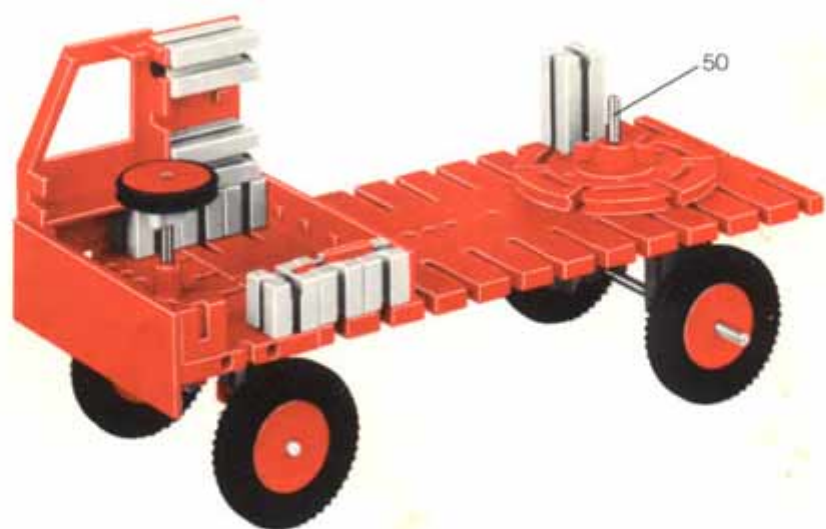
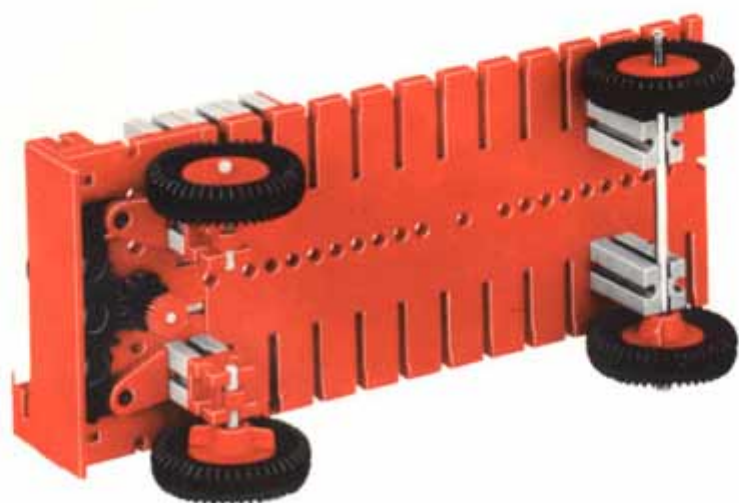





Statik 1 + 200



Feuerwehr
Fire engine
Autopompe
Brandweer

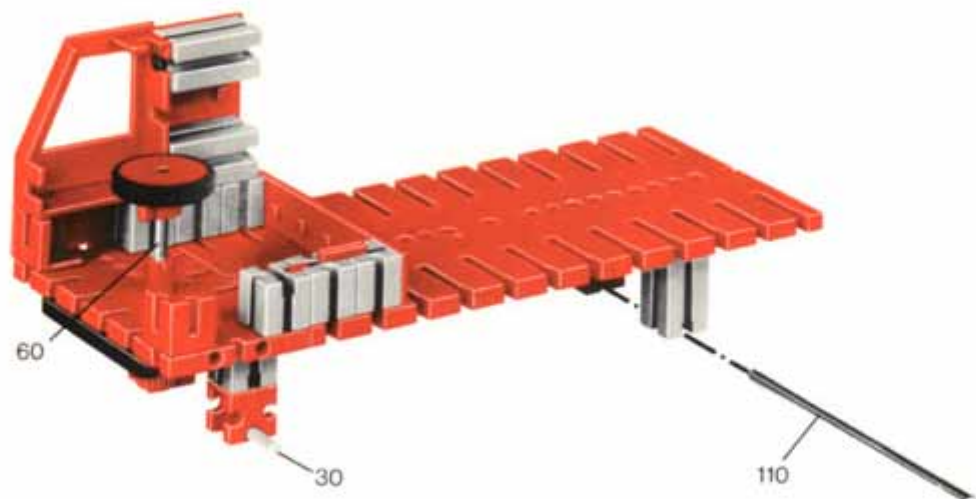
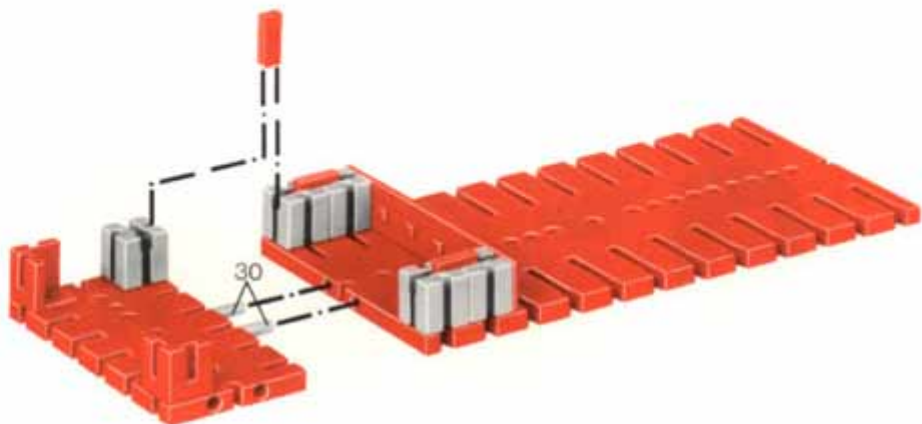

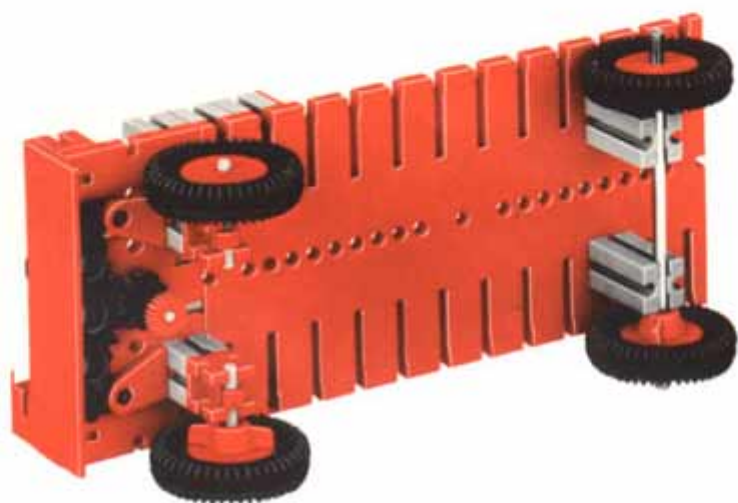





Statik 1 + 300



Turmdrehkran
Tower crane
Grue pivotante
Toren draaikraan

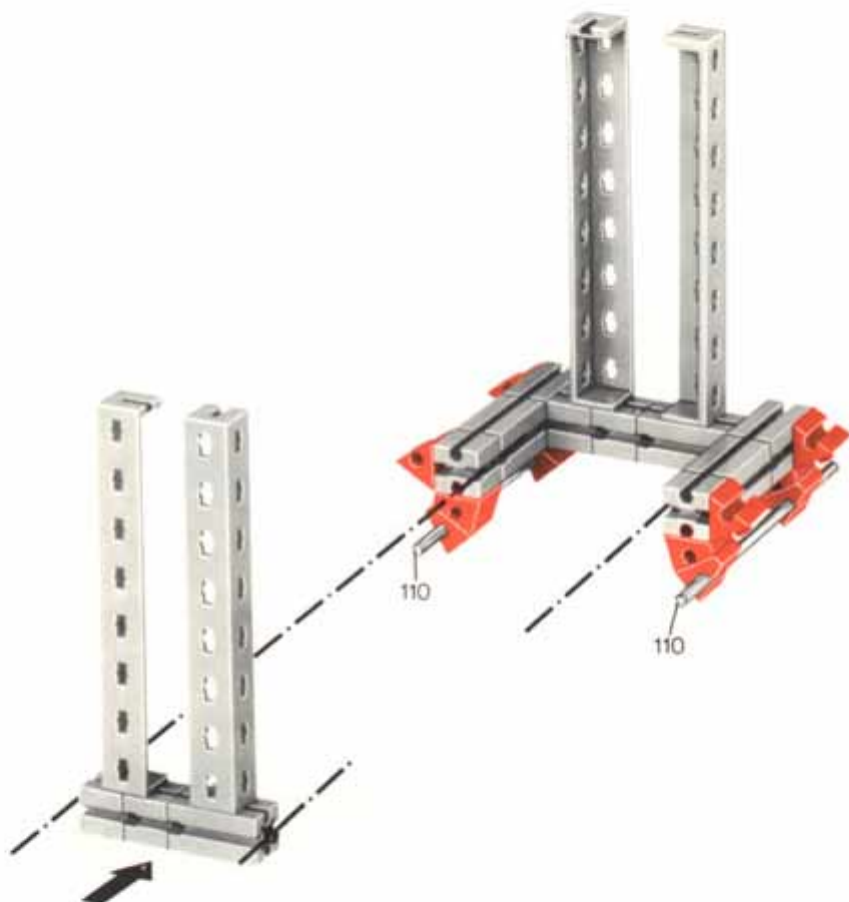



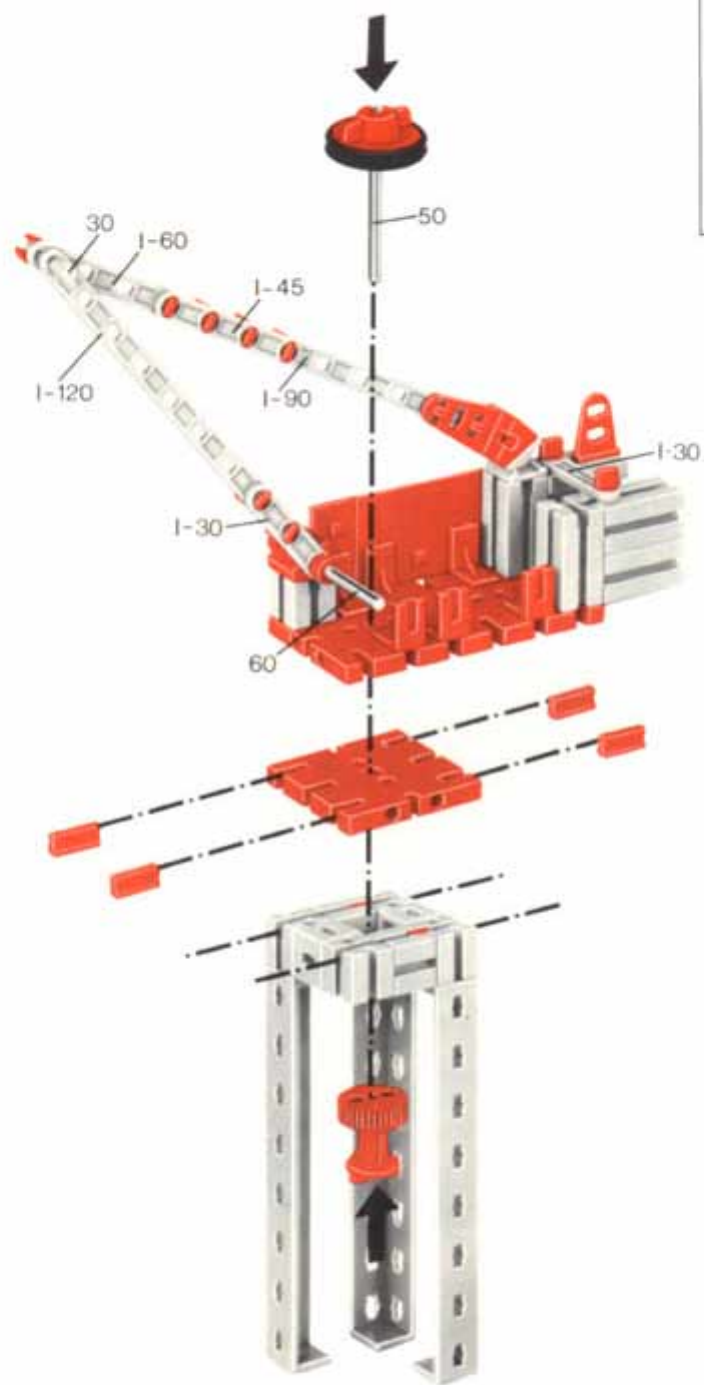



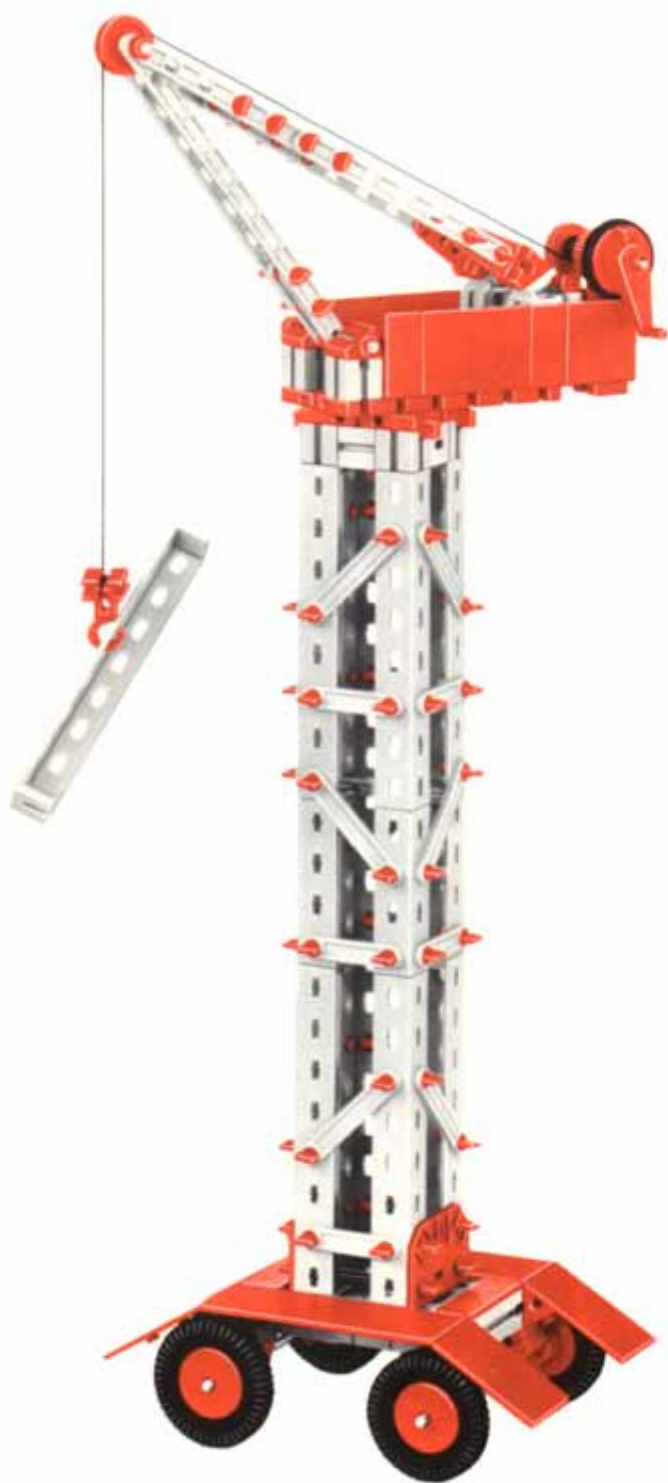

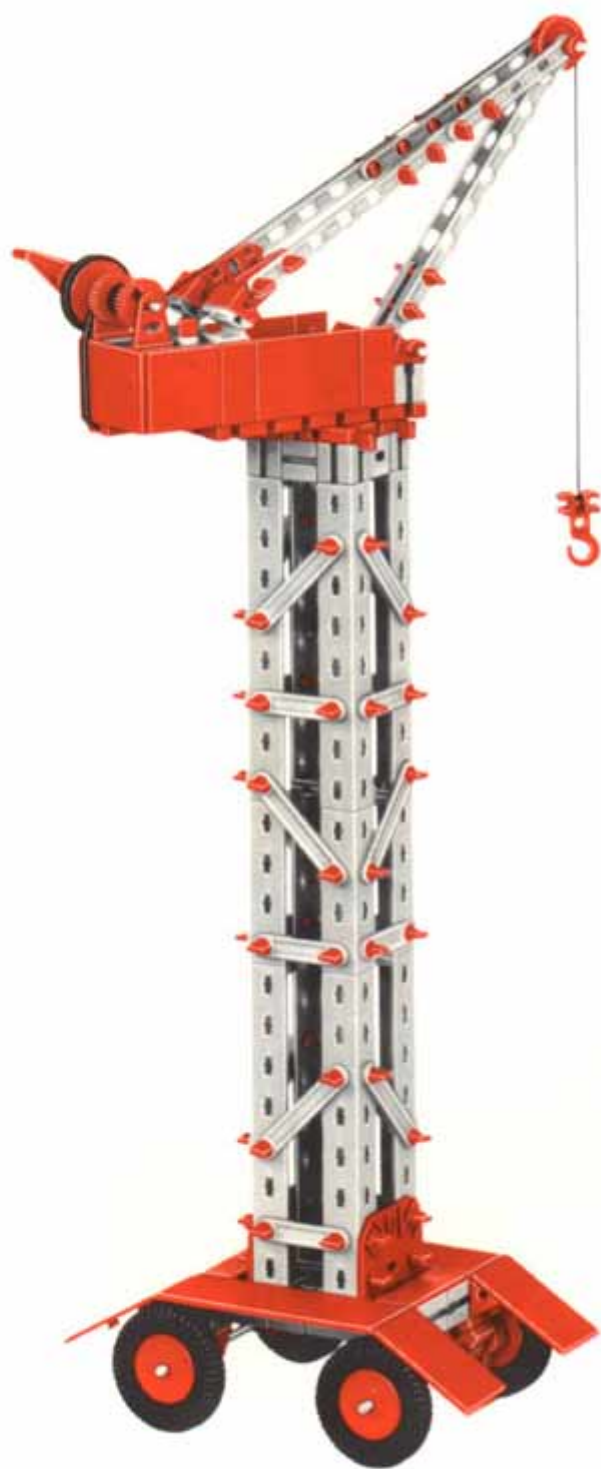

Statik 1 + 300





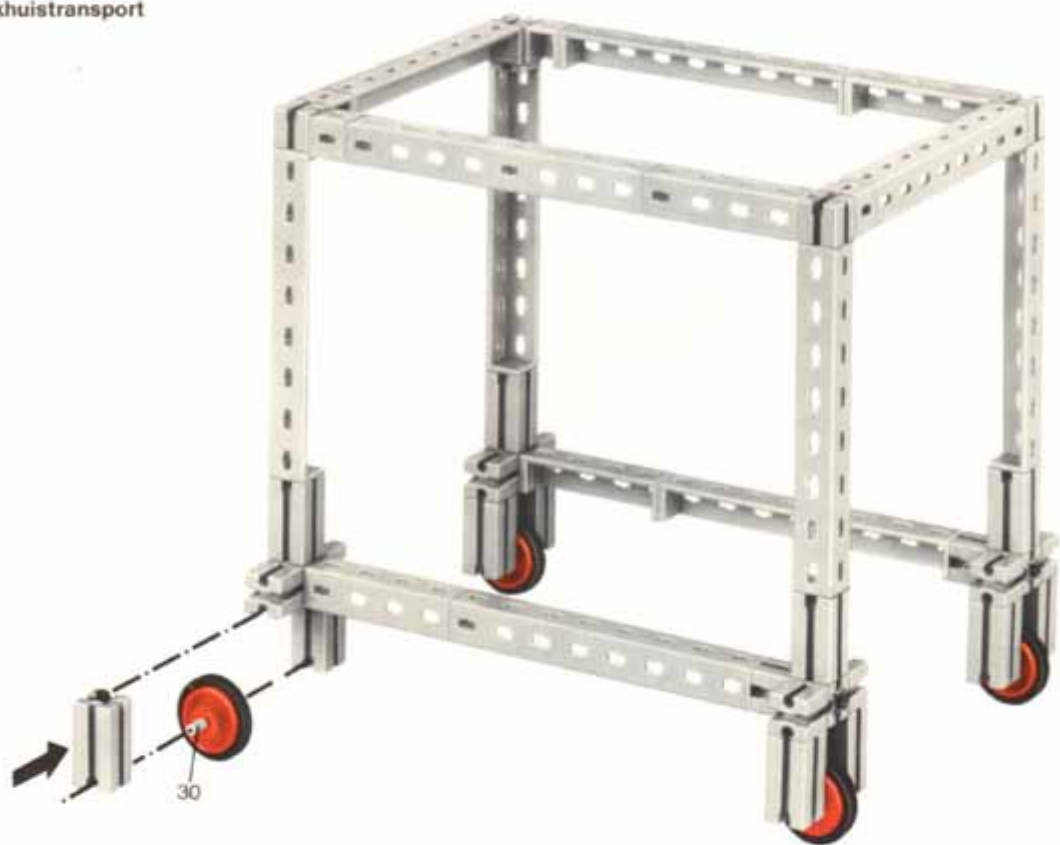

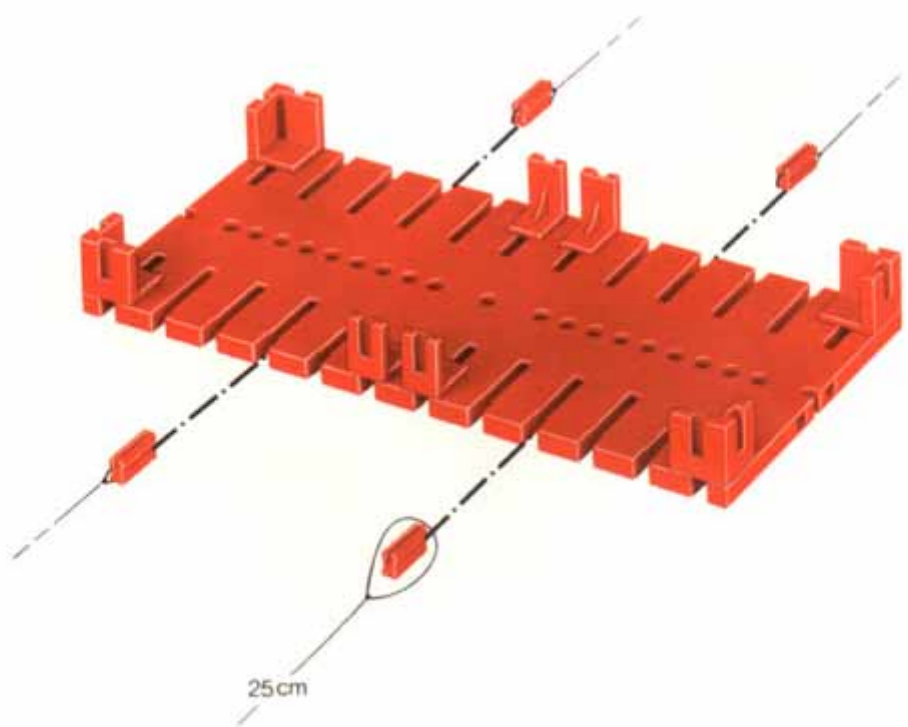
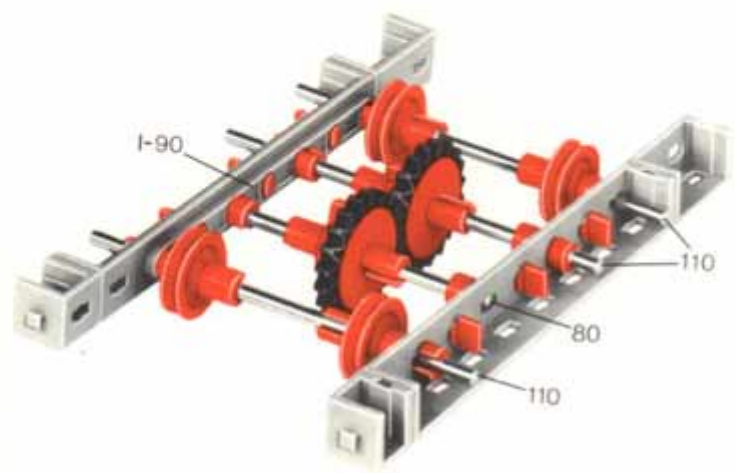

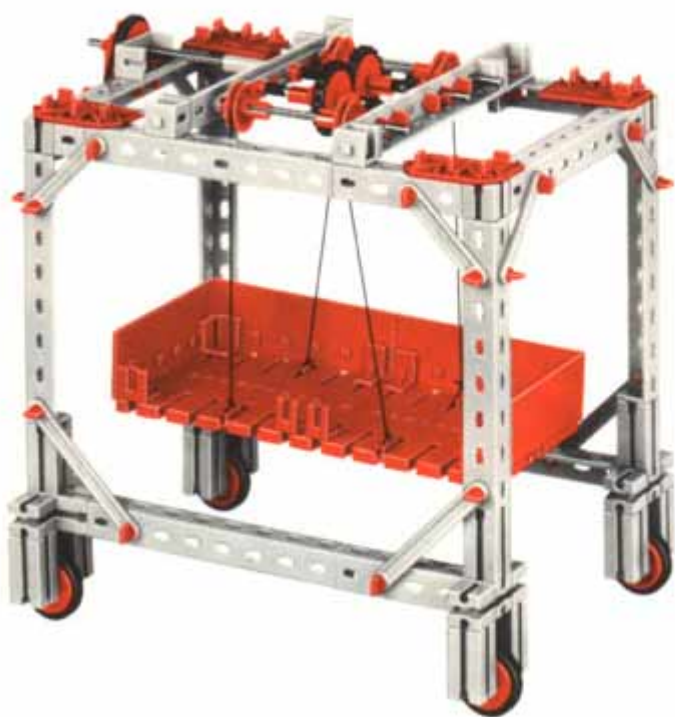















Lagerplatzkran
Parts lift and trans-
porter crane
Plateau de
stockixage grue
Pakhuistransport







Stückliste · Parts List · Nomenclature · Onderdelenlijst

	12	Winkelträger 120 · Angle girder 120 · Cornière de 120 · Hoekdraagsteun 120 4 36303 1		2	Lasche 15 · Connecting strip 15 · Eclisse de 15 · Rechtverbinding 15 4 36326 1
	4	Winkelträger 60 · Angle girder 60 · Cornière de 60 · Hoekdraagsteun 60 4 36302 1		2	Lasche 21,3 · Connecting strip 21,3 · Eclisse de 21,3 · Rechtverbinding 21,3 4 36327 1
	4	Winkelträger 30 · Angle girder 30 · Cornière de 30 · Hoekdraagsteun 30 4 36301 1		4	Doppelknotenplatte · Double gusset plate · Gousset · Dubbele hoekverbinding 4 35797 1
	2	Winkelträger 15 · Angle girder 15 · Cornière de 15 · Hoekdraagsteun 15 4 36300 1		70	S-Riegel 4 · Single rivet 4 mm · Rivet de 4 mm · S-grendel 4 mm 4 36323 1
	4	Winkelträger 15 mit 2 Zapfen · Angle girder 15 with two pins · Cornière de 15 à 2 tenons · Hoekdraagsteun 15 met 2 nokken 4 36304 1		15	S-Riegel 6 · Double rivet 6 mm · Rivet de 6 mm · S-grendel 6 mm 4 36324 1
	4	Scharnier · Hinge · Charnière · Scharnier 4 36329 1		4	S-Riegel 8 · Triple rivet 8 mm · Rivet de 8 mm · S-grendel 8 mm 4 36457 1
	12	Strebe 30 · I-strut 30 · Entretoise type I de 30 · I-spant 30 4 36309 1		15	Riegelscheibe · Locking washer · Disque d'arrêt · Grendelschijf 4 36334 1
	4	Strebe 45 · I-strut 45 · Entretoise type I de 45 · I-spant 45 4 36310 1		1	Nylonseil · Nylon cord · Filin Nylon · Nylon snoer 3 31027 1
	2	Strebe 45 mit Loch · I-strut 45 with holes · Entretoise type I à perf. mult. de 45 · I-spant 45 met gat 4 38536 1		1	S-Griff · Rivet holder · Tourne-rivet · S-greep 4 35800 1
	2	Strebe 60 mit Loch · I-strut 60 with holes · Entretoise type I à perf. mult. de 60 · I-spant 60 met gat 4 38535 1		1	Kassetten-Unterteil · Cassette, bottom · Coffret, partie inférieure · Cassette, onderstuk 4 35359 1
	12	Strebe 42,4 · X-strut 42,4 · Entretoise type X de 42,4 · X-spant 42,4 4 36315 1		1	Kassetten-Deckel · Cassette, top · Coffret, partie supérieure · Cassette, deksel 4 35360 1
	4	Strebe 63,6 · X-strut 63,6 · Entretoise type X de 63,6 · X-spant 63,6 4 36316 1			

Statik 1 + Statik 2 + 100

Modell aus Statik 2
Model out of Statik 2
Modèl realizé à
Statik 2
Modell uit Statik 2

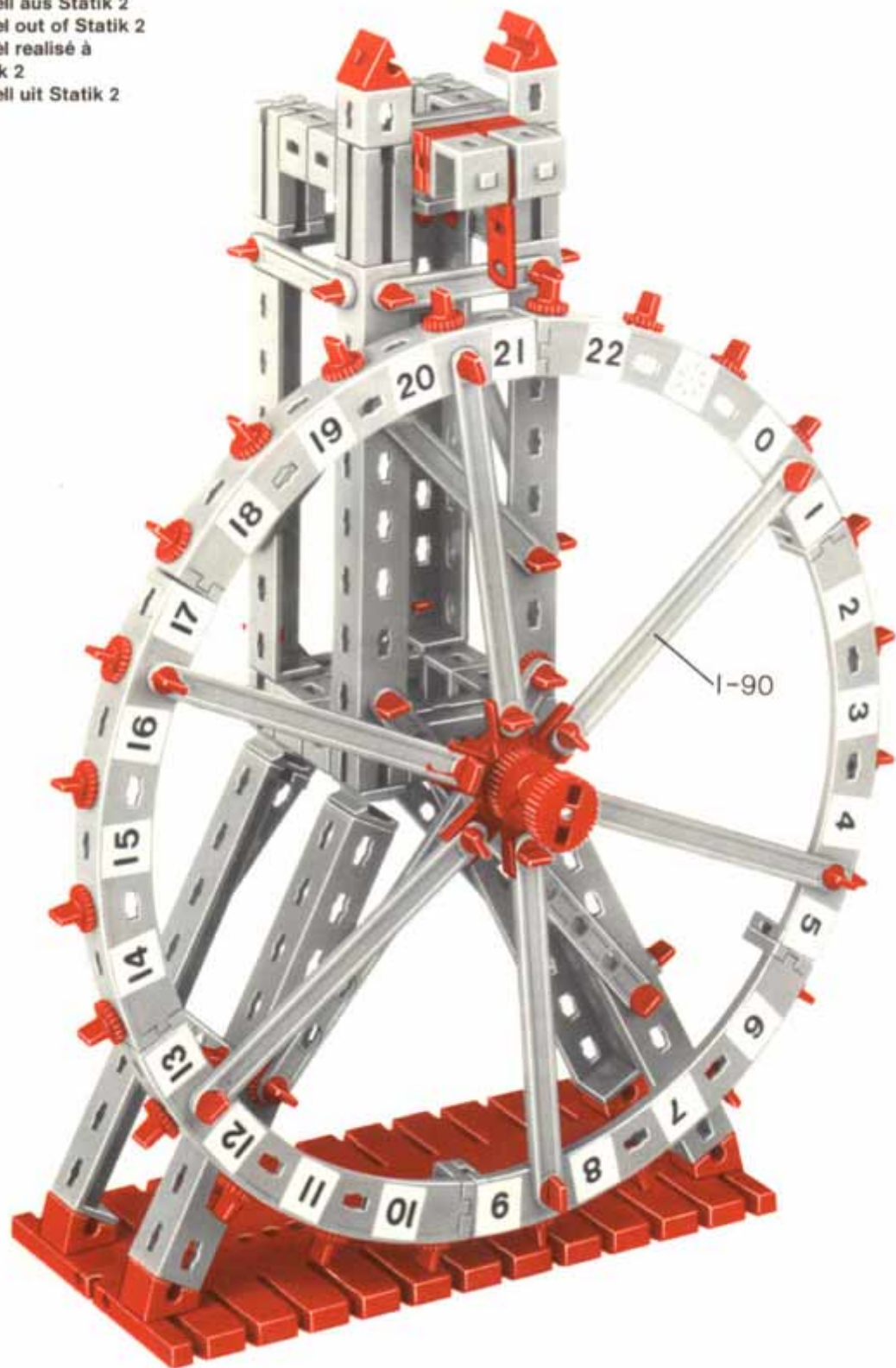

Statik 1 + Statik 2 + Statik 3 + 50

Modell aus Statik 3
Model out of Statik 3
Modèl réalisé à
Statik 3
Modell uit Statik 3

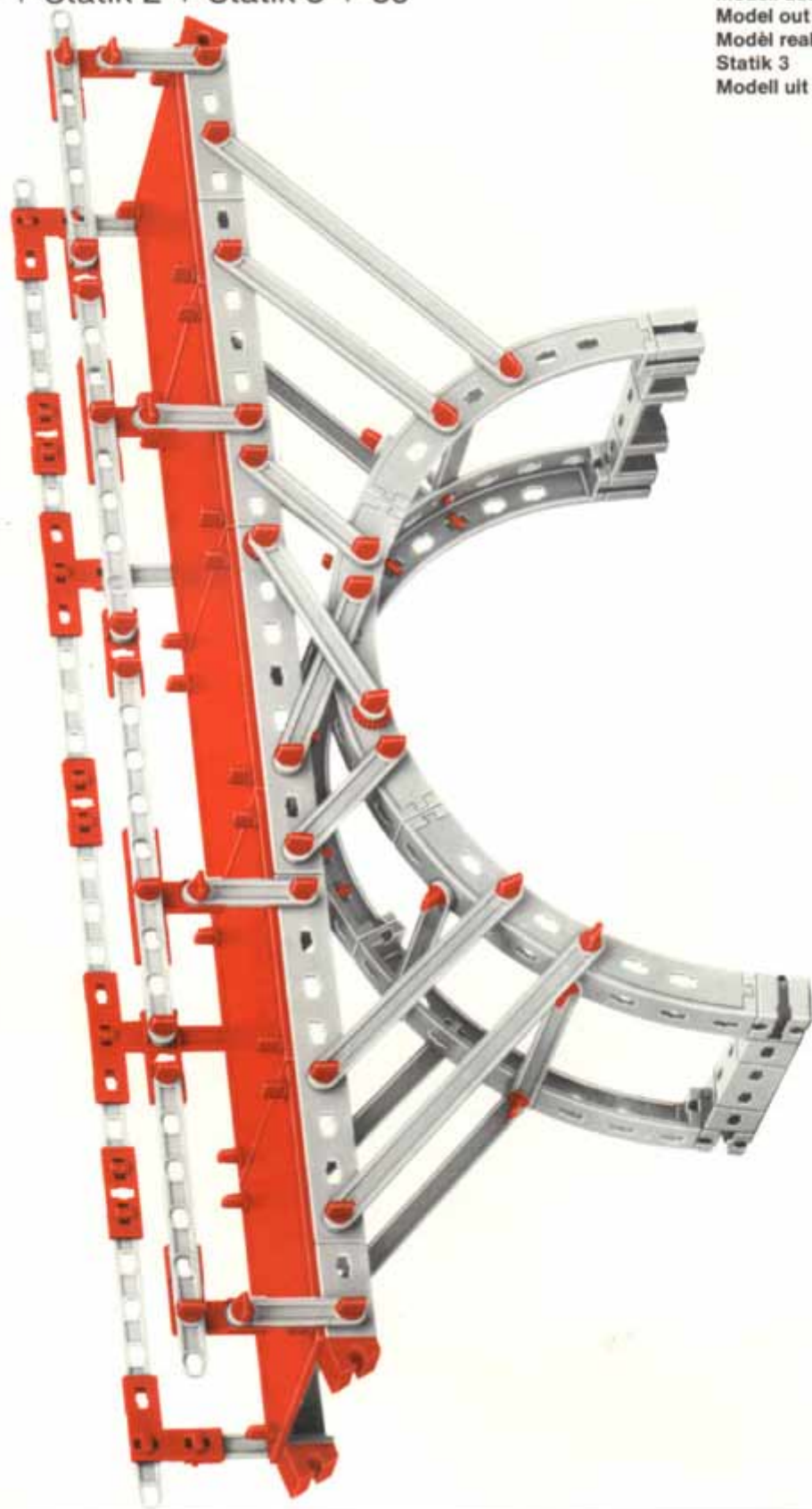

Modelle aus dem fischertechnik
Elektromechanik Baukasten em 1
Models built using the fischertechnik
electro-mechanical construction kit
Modèles réalisés à partir de la
boîte d'électromécanique
Modellen uit de fischertechnik
elektromechanika bouwdoos

