

fischer[®]technik



50 S/1

Aufbau-Statikkasten
structural
extension kit
boîte complémentaire
«superstructure»
cassetta statica
d'integrazione
aanbouw statikadoos



Art.-Nr. 6 39121 5

Aufbaustufen
der fischertechnik-
Statikkästen

extension packs for
fischertechnik structural
sets

possibilités d'extension
des boîtes «superstructure»
fischertechnik
fasi d'ampliamento delle
cassette fischertechnik
statica

uitbreidingsfasen van
de fischertechnik
statikadozen

▷ 100 S = 50 S + 50 S/1
200 S = 50 S + 50 S/1 + 50 S/2
300 S = 50 S + 50 S/1 + 50 S/2 + 50 S/3

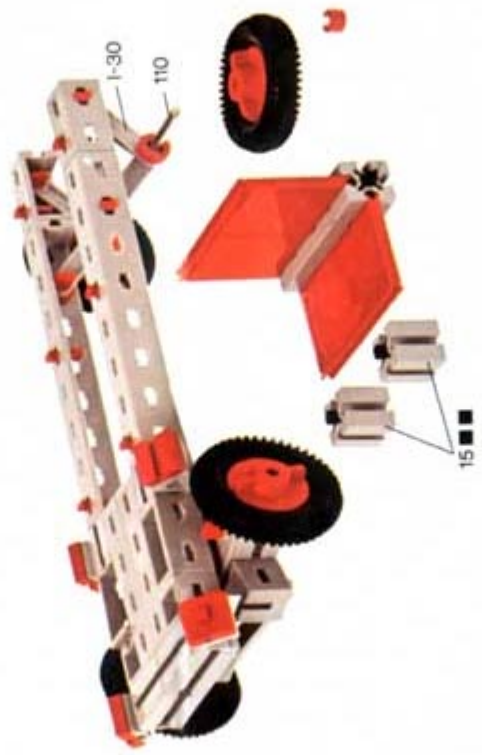

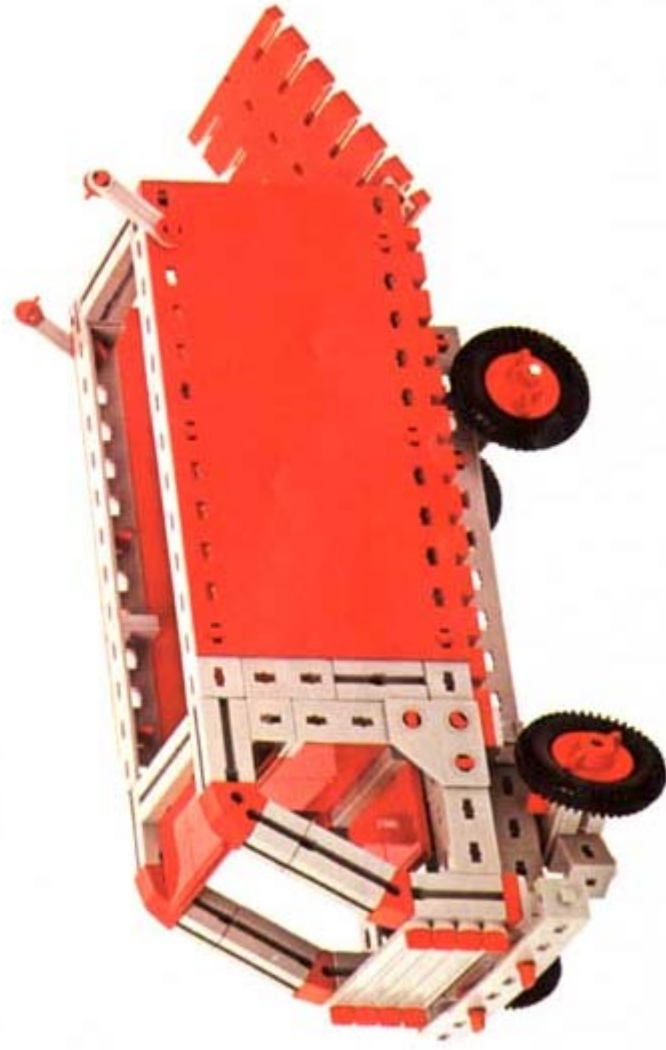
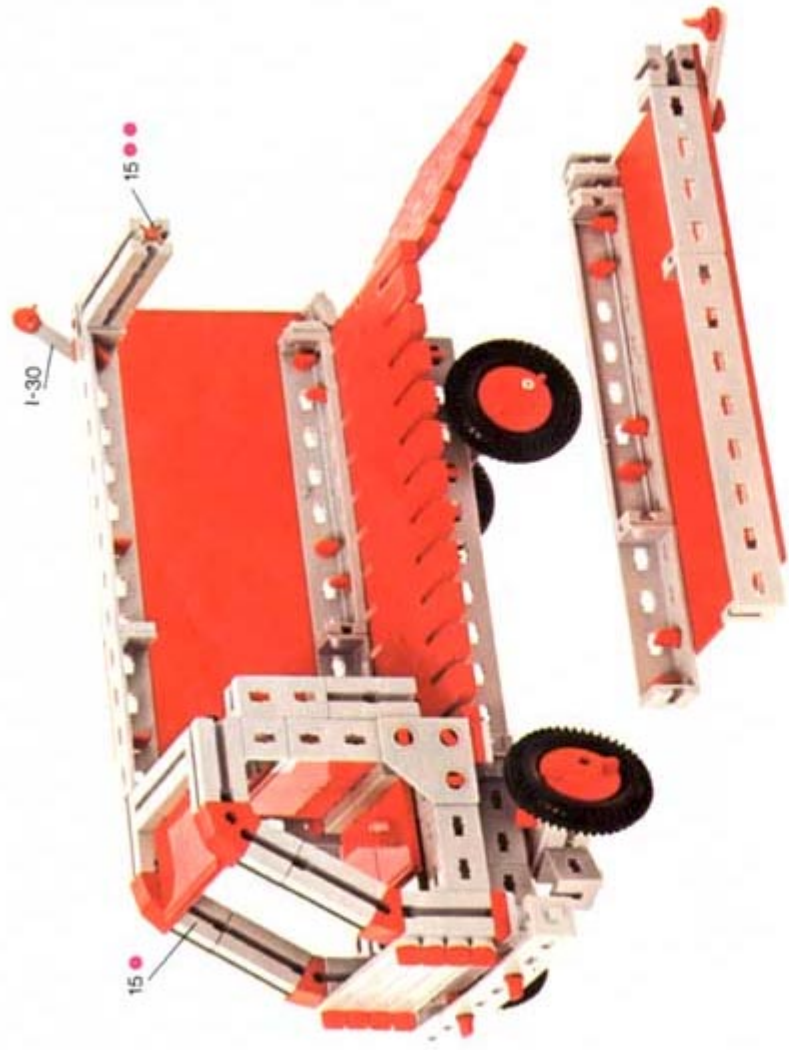

Zusammenfügen des Flachträgers mit Flachstück
Connecting the flat girders with flat



Assemblage de la cornière plate avec un raccord plat
Collegamento di piastre nodali e diagonali
Samenvoegen van de vlakke draagsteun
met vlakke steun

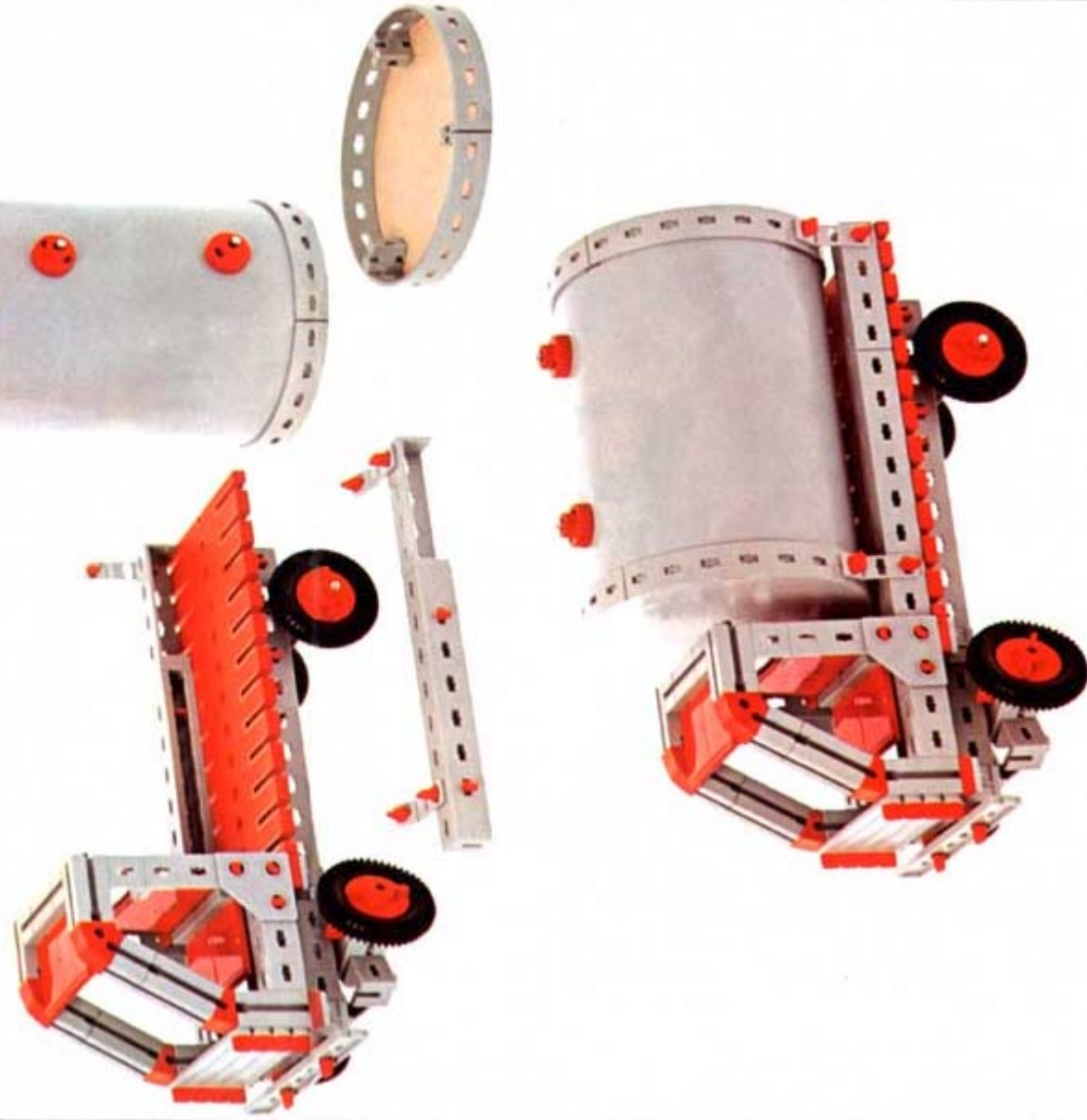

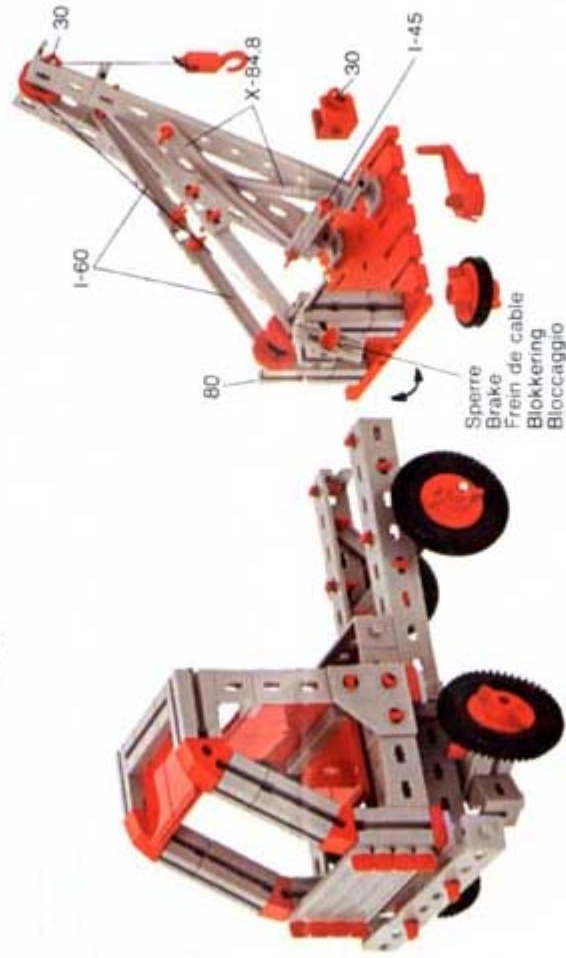
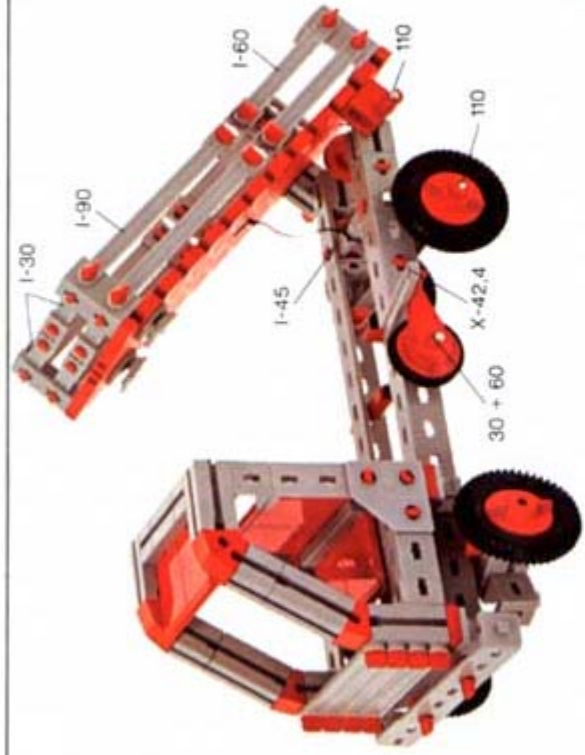

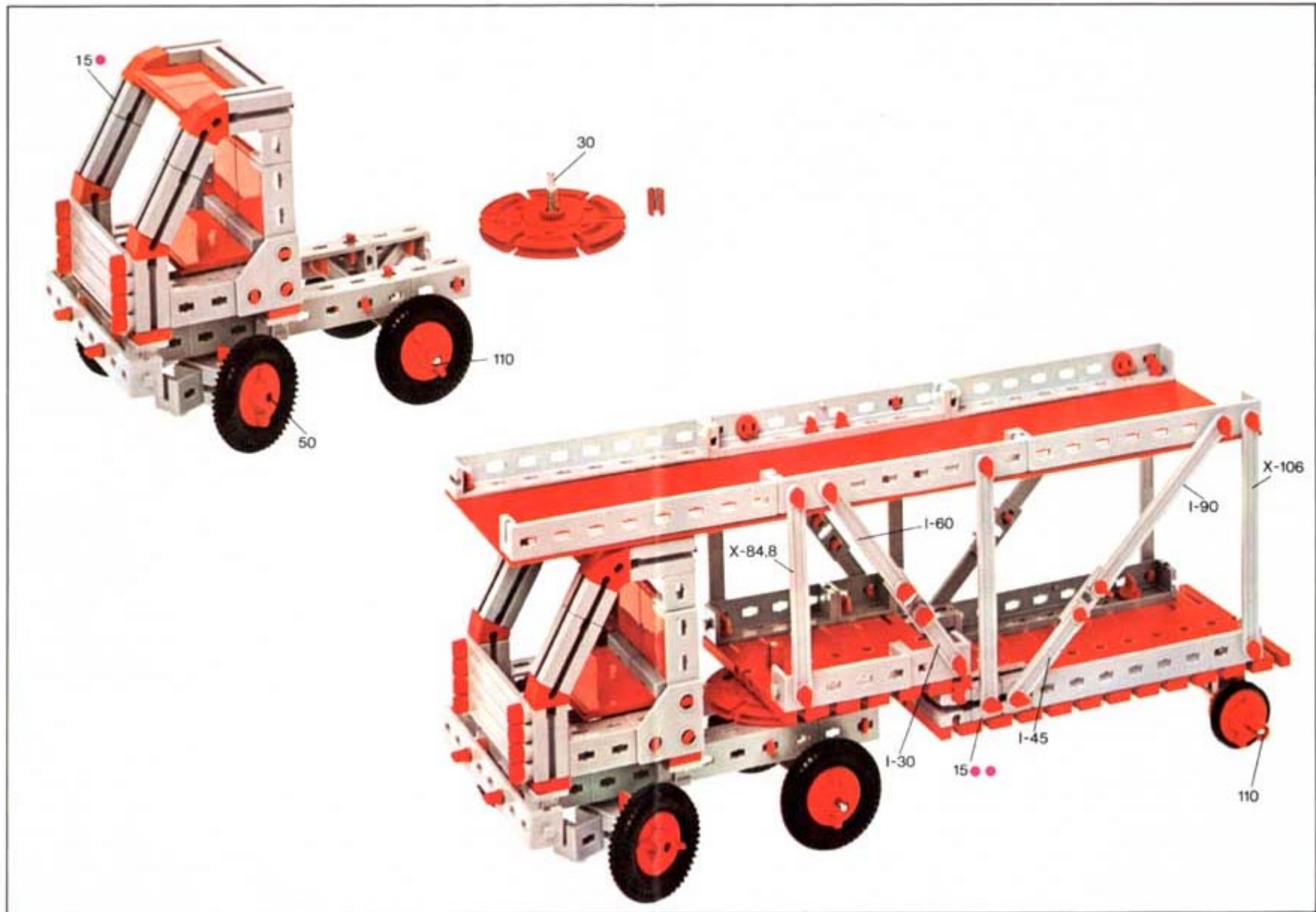

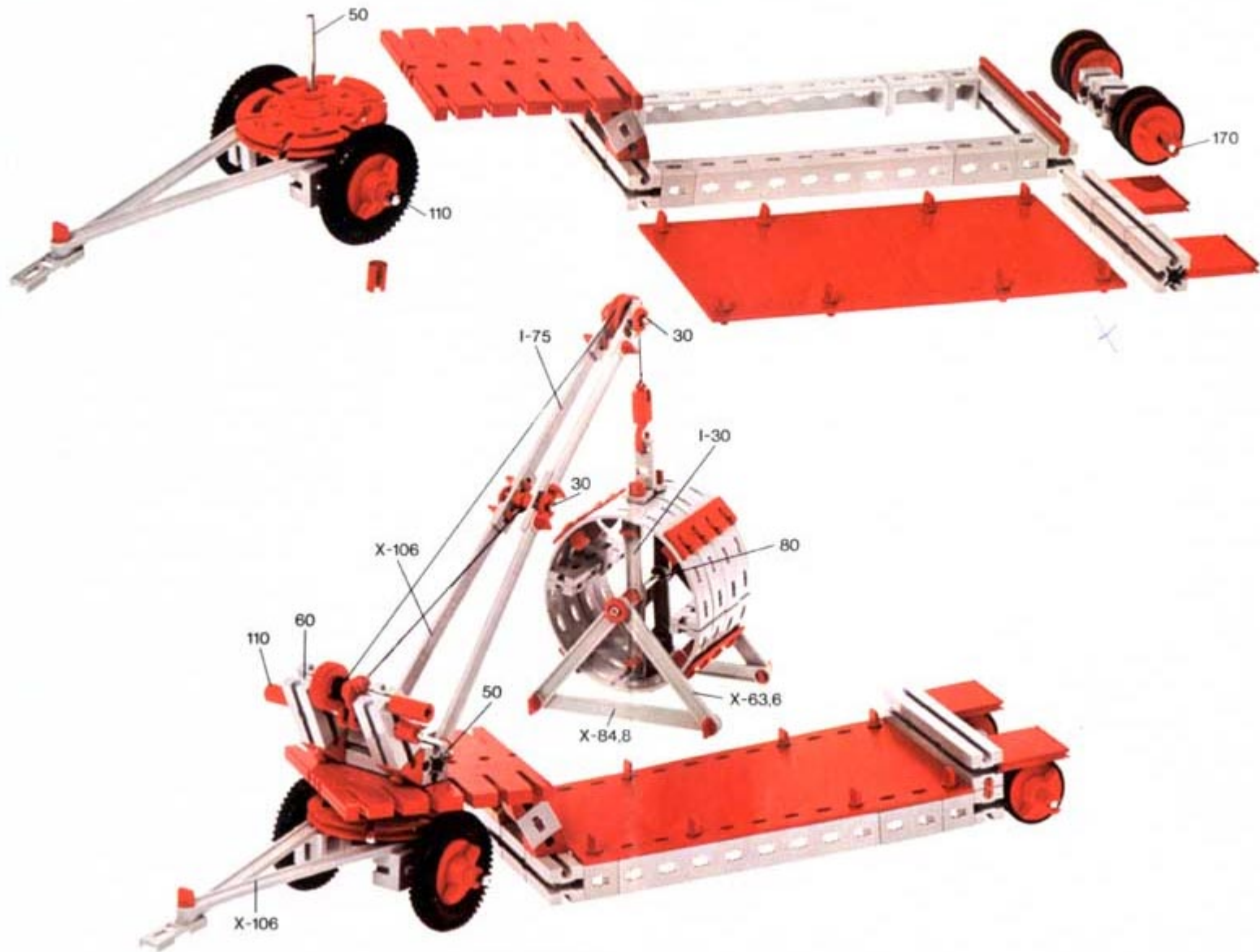

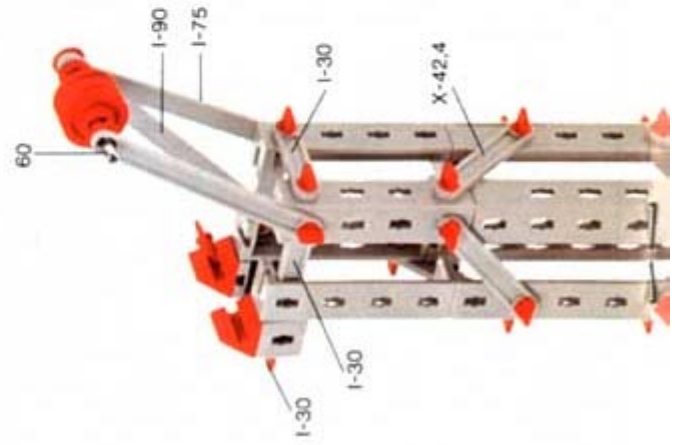

Sperre
Brake
Frein de cable
Blokking
Bloccaggio

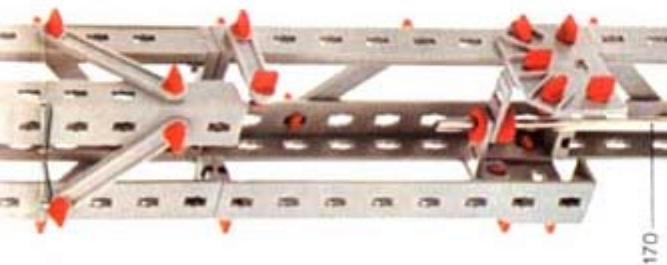
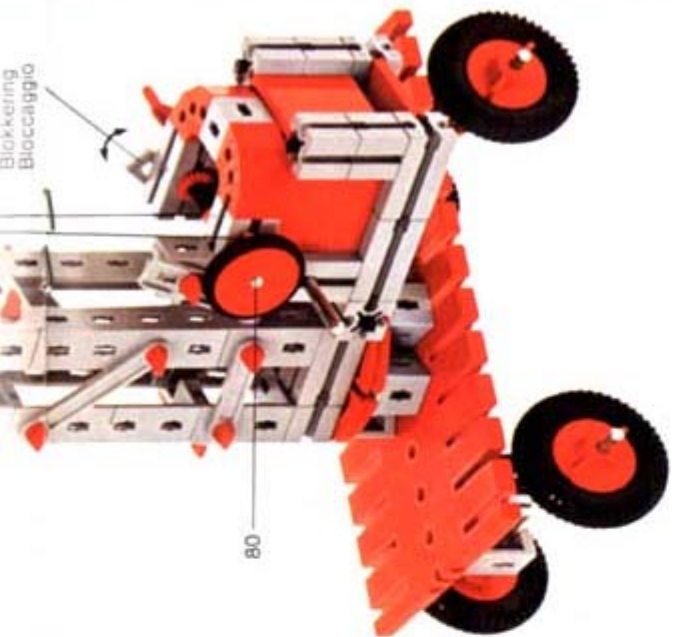
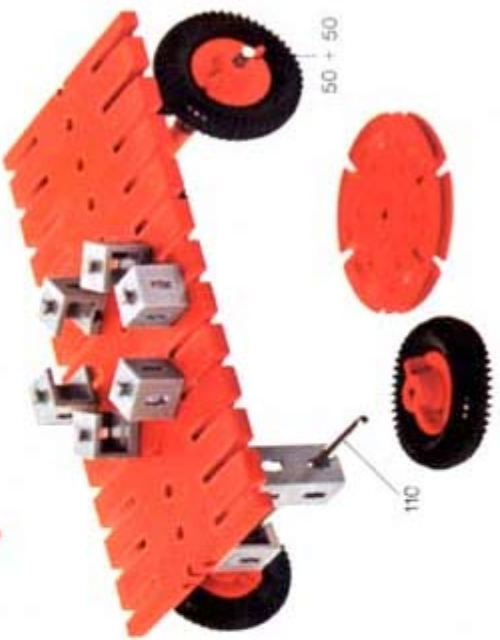

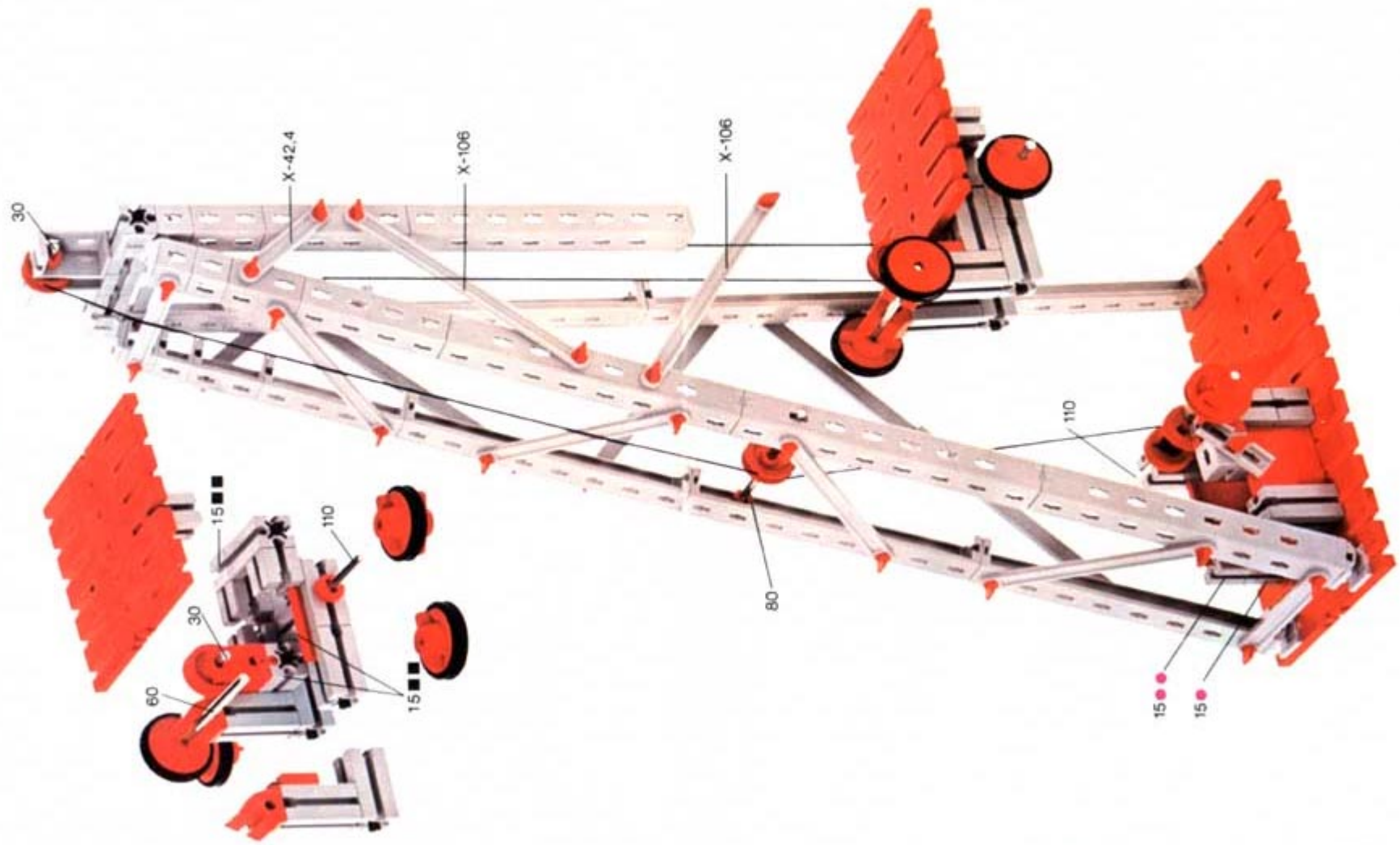

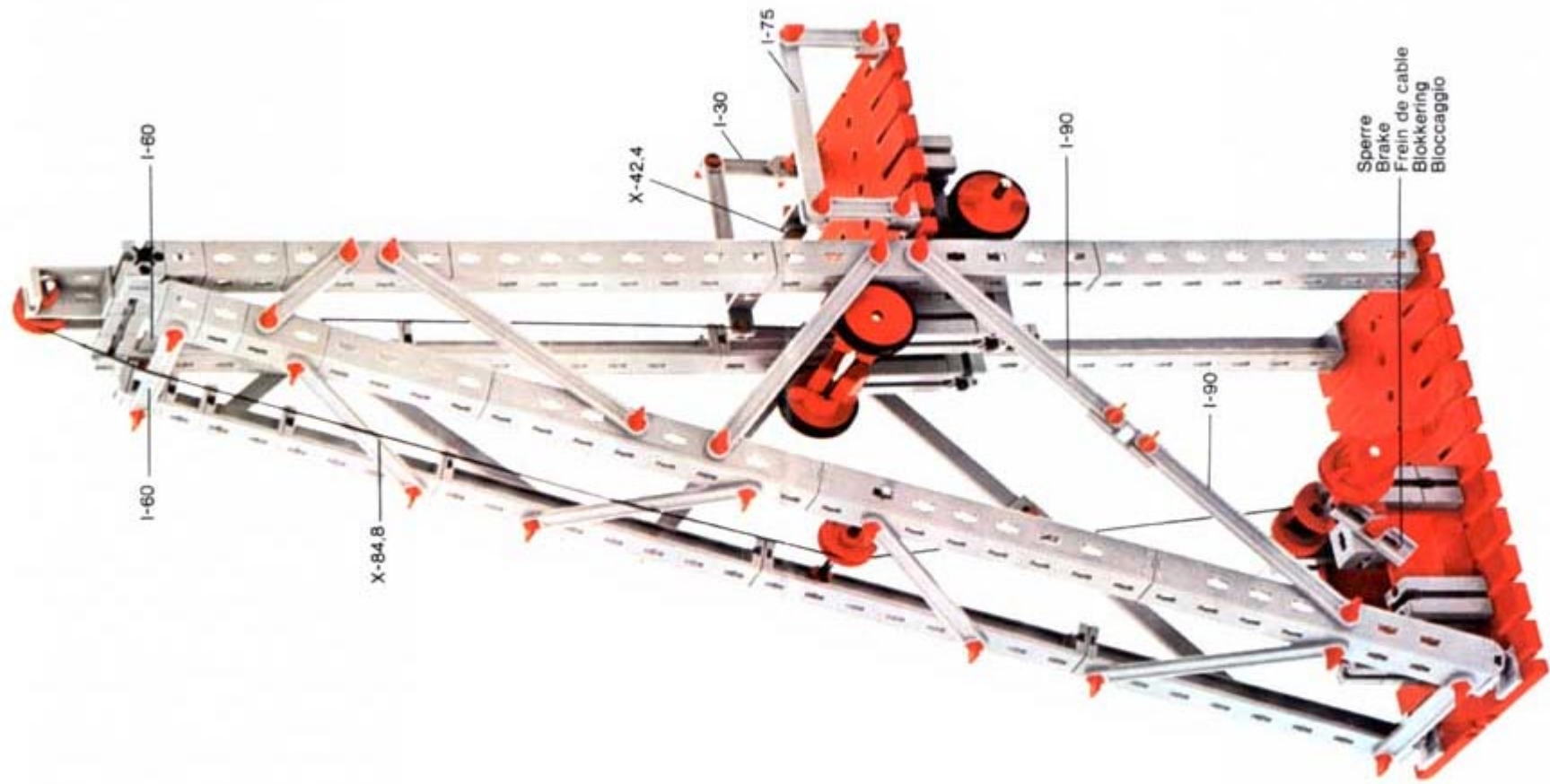

I-60

I-60

X-84.8

X-42.4

I-30

I-75

I-90

I-90

Sperr
Brake
Frein de cable
Blokkering
Bloccaggio

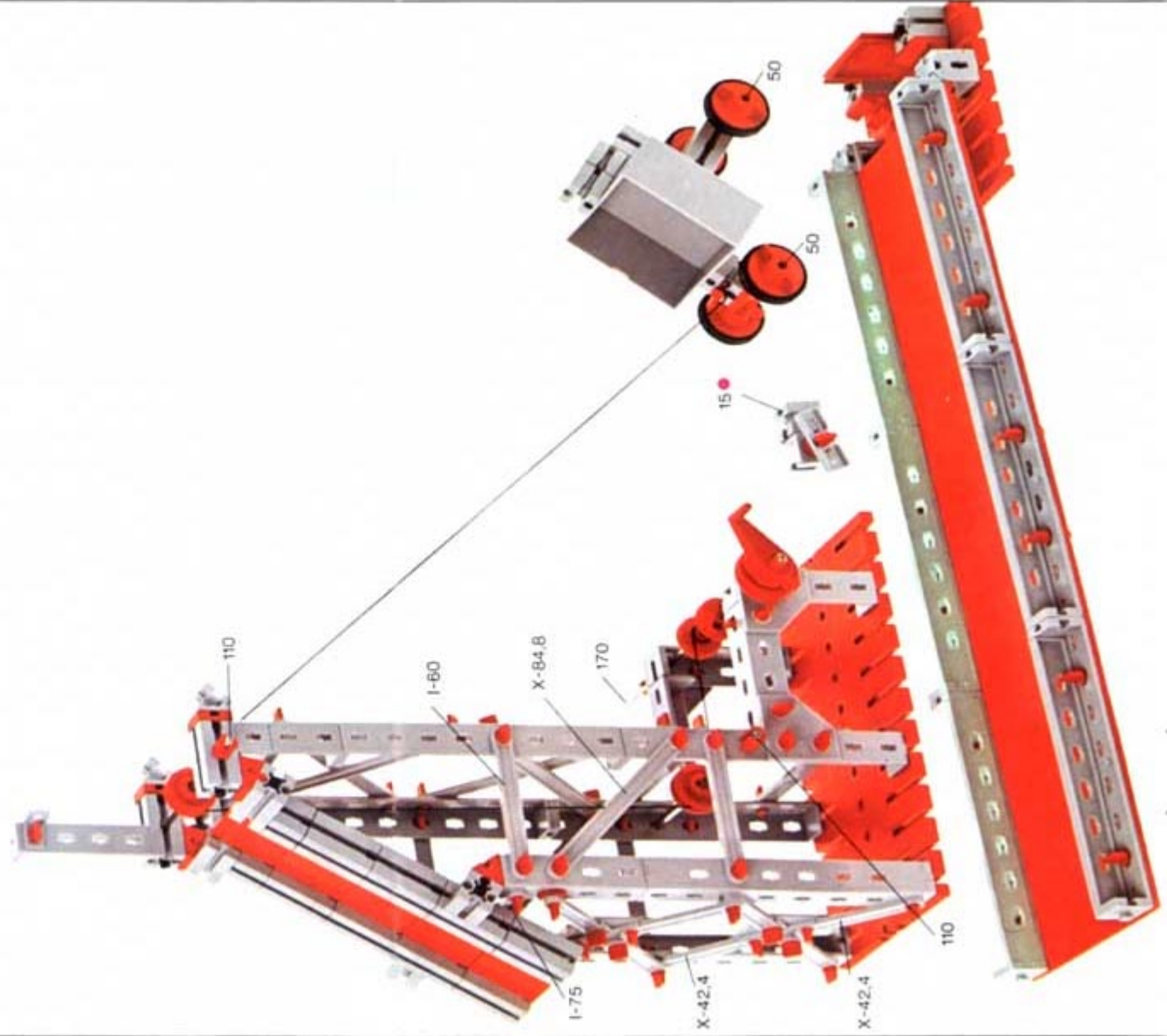



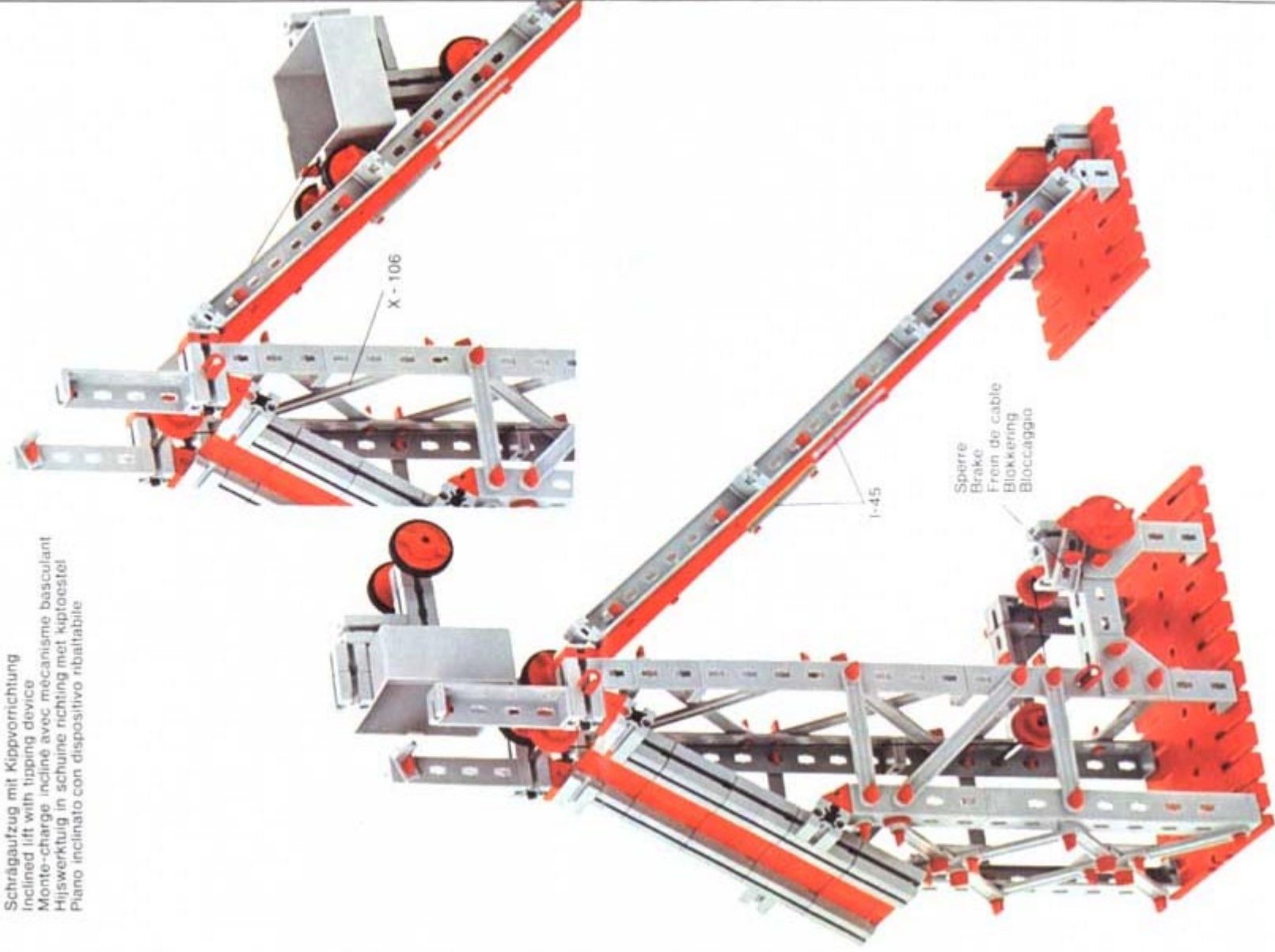



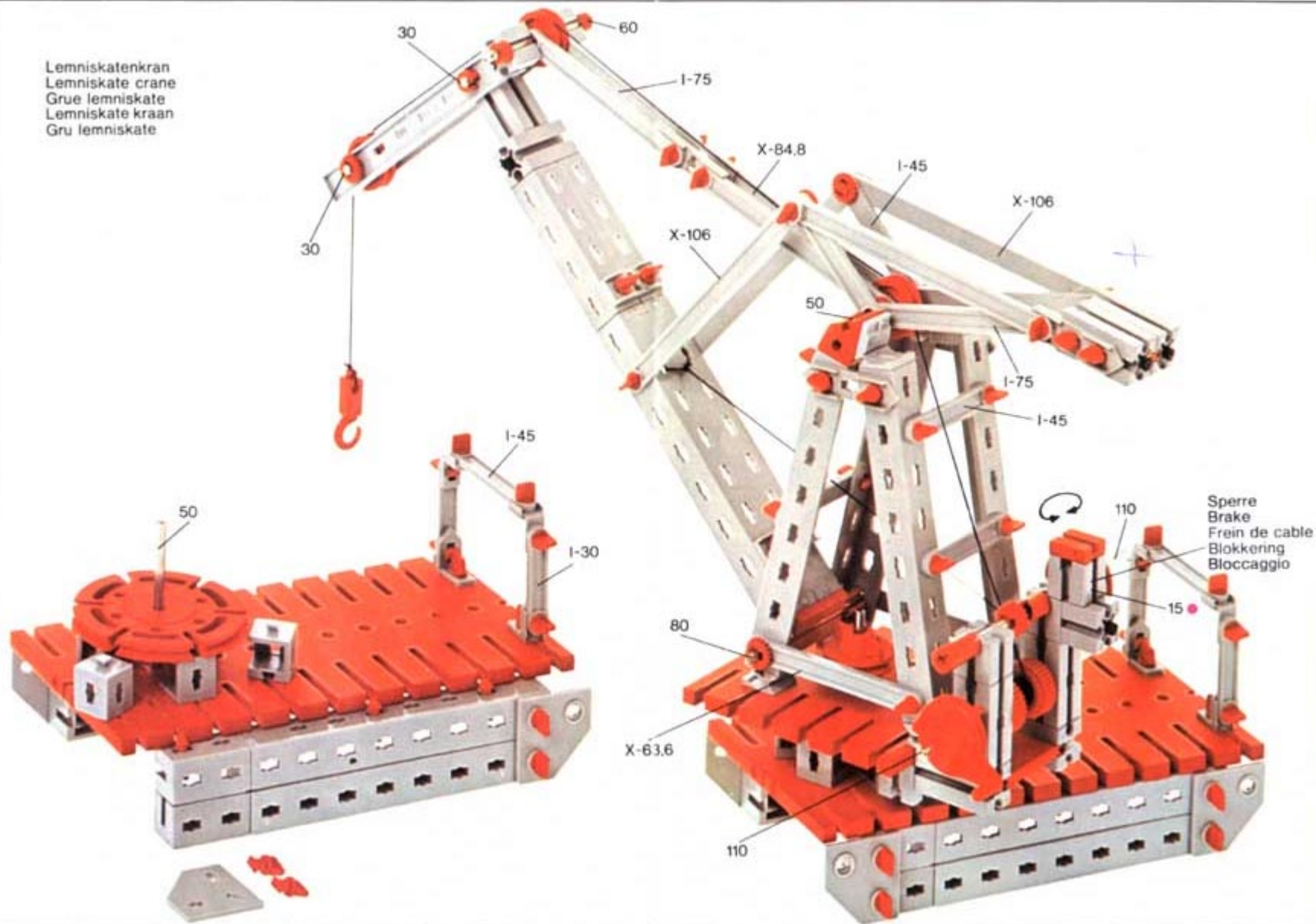





Schrägaufzug mit Kippvorrichtung
Inclined lift with tipping device
Monte-charge incliné avec mécanisme basculant
Hijswerktuig in schuine richting met kiptoestel
Piano inclinato con dispositivo ribaltabile



Lemniskatenkran
 Lemniskate crane
 Grue lemniskate
 Lemniskate kraan
 Gru lemniskate



Stückliste · part list · nomenclature · elenco dei pezzi · onderdelen lijst

Abbildung	Artikel- Nummer	50 S/t Stück	Benennung	Zusatz- kasten
	4 36300 1	4	Winkelträger 15 · angle girder 15 corniere de 15 · trave angolare 15 hoekdraagsteun 15	ft051 2
	4 36301 1	4	Winkelträger 30 · angle girder 30 corniere de 30 · trave angolare 30 hoekdraagsteun 30	ft051 4
	4 36302 1	4	Winkelträger 60 · angle girder 60 corniere de 60 · trave angolare 60 hoekdraagsteun 60	ft051 2
	4 36305 1	8	Flachträger 120 · flat girder 120 trave de 120 · trave piatta 120 vlakke draagsteun 120	ft057 3
	4 36307 1	8	Flachstück 120 · flat strut 120 element plat de 120 · pezzo piatto 120 · vlakke steun 120	ft057 5
	4 36321 1	2	Platte 180 x 90 · plate 180 x 90 plaque de 180 x 90 · piastra 180 x 90 plaat 180 x 90	ft054 2
	4 36326 1	2	Lasche 15 · fish-plate 15 ecclisse de 15 · copngunto 15 rechtverbindungsstück 15	ft053 4
	4 36327 1	4	Lasche 21,3 · fish-plate 21,3 ecclisse de 21,3 · copngunto 21,3 rechtverbindungsstück 21,3	ft053 4
	4 36325 1	4	Eckknotenplatte · corner connector plate · gousset d'angle piastra nodale angolare hoekknoopplaat	ft053 2
	4 36322 1	2	Kreuzknotenplatte · nodal connector plate · gousset à croisillon · piastra nodale a croce kruisknopplaat	ft053 2
	4 35797 1	4	Doppelknotenplatte · dual connector plate · gousset d'angle double · piastra nodale doppia dubbele knoopplaat	ft053 2
	3 36518 1	1	Kassette · case · coffret cassetta · cassette	ft027 3
	4 36329 1	4	Scharnier · hinge charniere · cerniera scharnier	ft053 8

