

# MASTER PLUS

## SKY HOPPERS

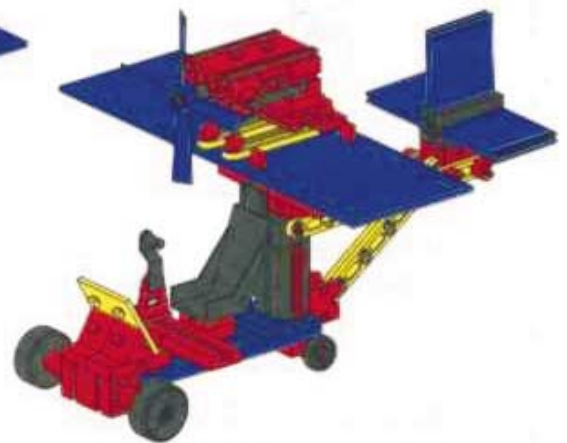

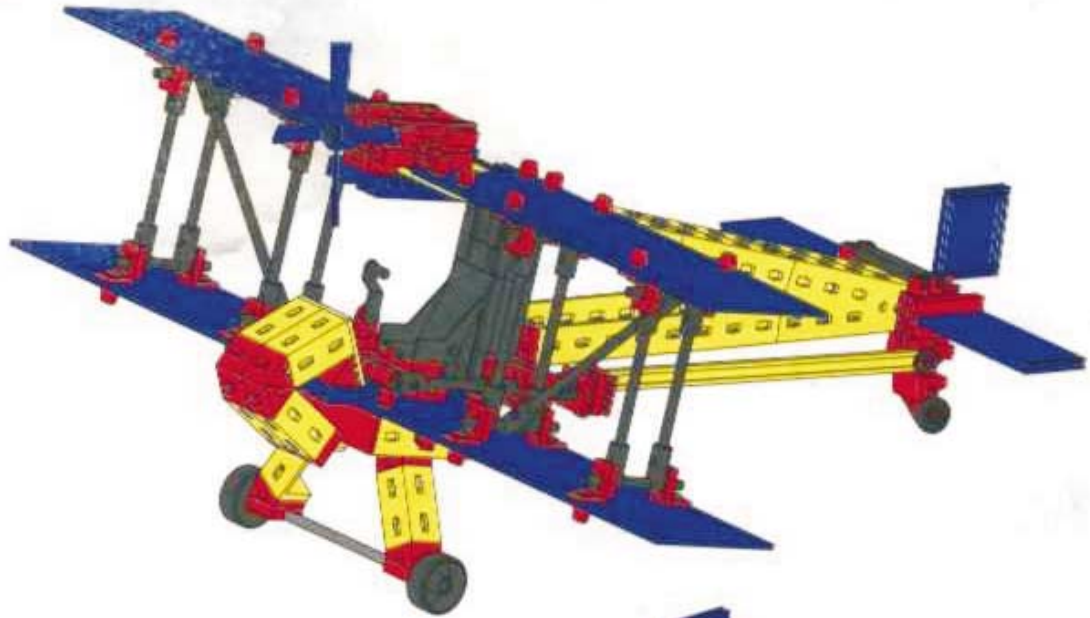

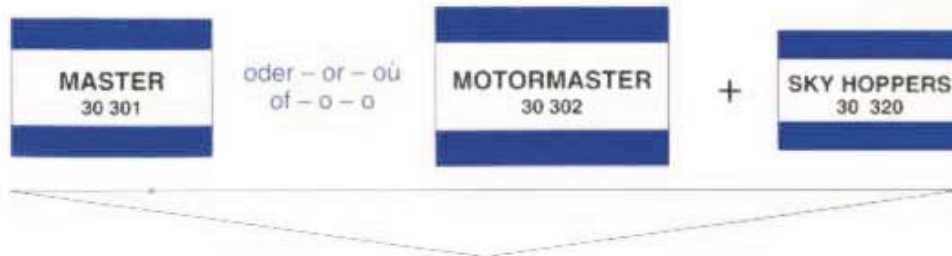







































































<b>Einzelteilübersicht</b> • Spare parts list • Liste des pièces détachées Onderdelenoverzicht • Lista de piezas • Lista dei pezzi	1
<b>Ultraleichtflugzeug</b> • Ultralight aircraft • Avión ultraligero Ultra Light vliegtuig • Aeroplano di lega leggera • ULM	3
<b>Schulflugzeug</b> • Training aircraft • Avion-école Lesvliegtuig • Avión para enseñanza • Velivolo per addestramento	5
<b>Flugzeug mit Tower</b> • Aircraft with tower • Avion avec tour de contrôle Vliegtuig met verkeerstoren • Aeroplano con torre • Aeroplano con tower	8
<b>Wasserflugzeug</b> • Seaplane • Hidroplano Watervliegtuig • Idrovolanto • Hydravion	12
<b>Piper Alpha</b>	15
<b>Doppeldecker</b> • Biplane • Biplano Tweedekker • Biplano • Biplan	18
<b>Motorisierung</b> • Motor unit • Motorisation Motorisçring • Motorización • Motorizzazione	22

**Einzelteilübersicht**  
**Spare parts list**  
**Liste des pièces détachée**

**Onderdelenoverzicht**  
**Lista da piezas**  
**Lista dei pezzi**

	31010 12x		31984 1x		35063 1x		35980 6x
	31011 2x		31994 1x		35064 1x		36297 2x
	31040 1x		32064 1x		35065 8x		36299 2x
	31060 1x		32071 5x		35066 2x		36324 4x
	31124 2x		32085 1x		35069 1x		36328 4x
	31330 2x		32200 8x		35073 4x		36330 2x
	31597 2x		32879 3x		35076 4x		36335 3x
	31670 16x		32881 5x		35405 1x		36573 2x
	31765 1x		35049 10x		35668 2x		36574 2x
	31848 4x		35052 2x		35799 1x		36586 2x
	31905 1x		35053 6x		35973 1x		37468 4x
	31909 1x		35054 2x		35975 1x		37661 1x
	31982 7x		35059 4x		35977 1x		38241 1x

	38245 2x		36336 1x				
	38249 1x		36337 1x				
	38251 4x		36338 2x				
	38253 4x		36339 4x				
	38266 1x		36340 4x				
	38413 3x		36341 3x				
	38415 9x		36342 2x				
	38423 2x		36521 2x				
	38428 3x						
	38464 2x						
	38531 2x						
	38843 1x						
	36227 20x						

Ultraleichtflugzeug  
 Ultralight aircraft  
 Avión ultraligero

Ultra Light vliegtuig  
 Aeroplano di lega leggera  
 ULM

1

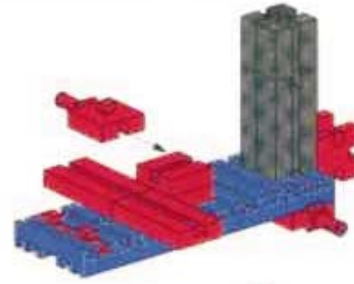
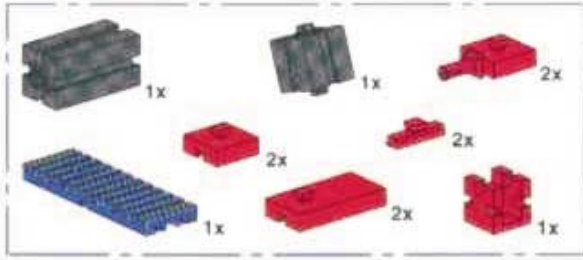

2

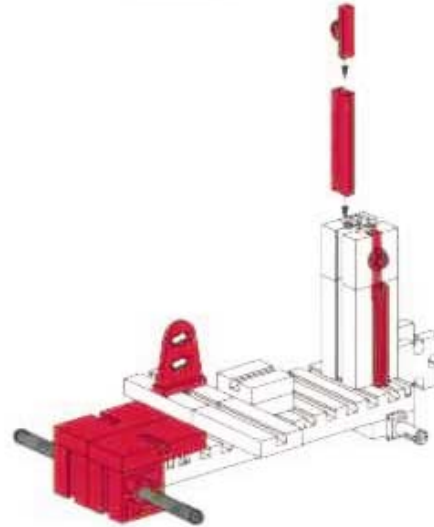
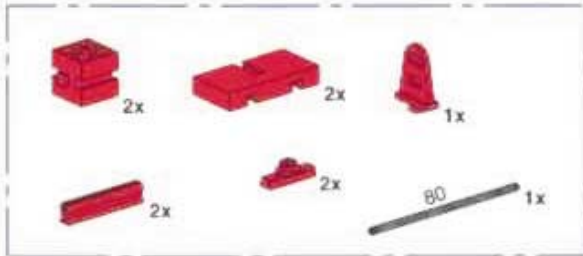

3

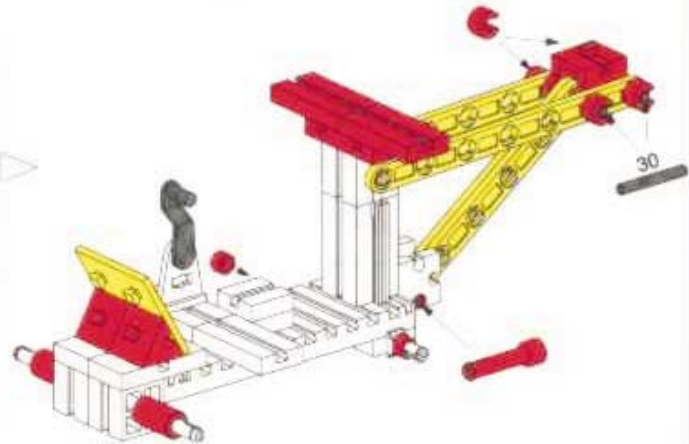
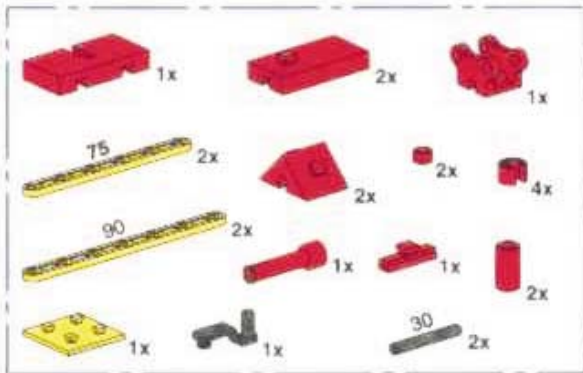

4

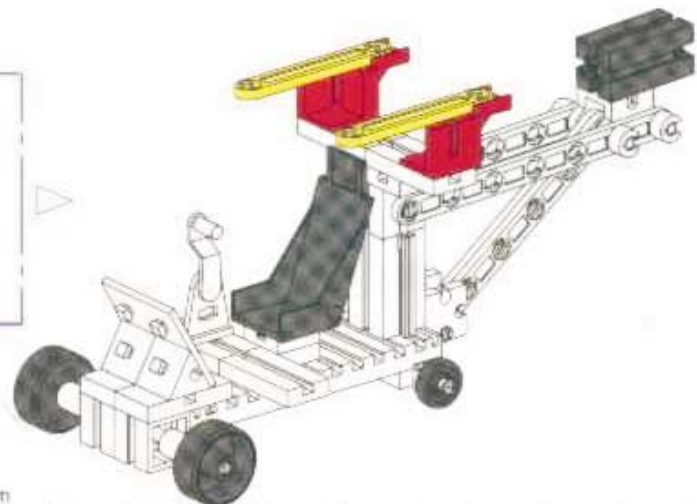
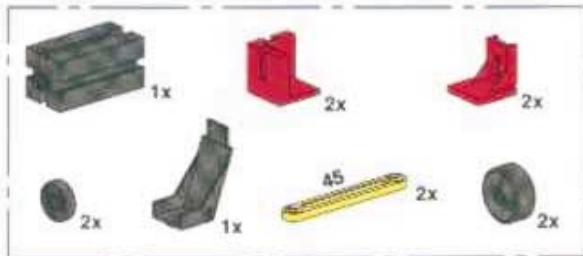

30mm

80mm

5

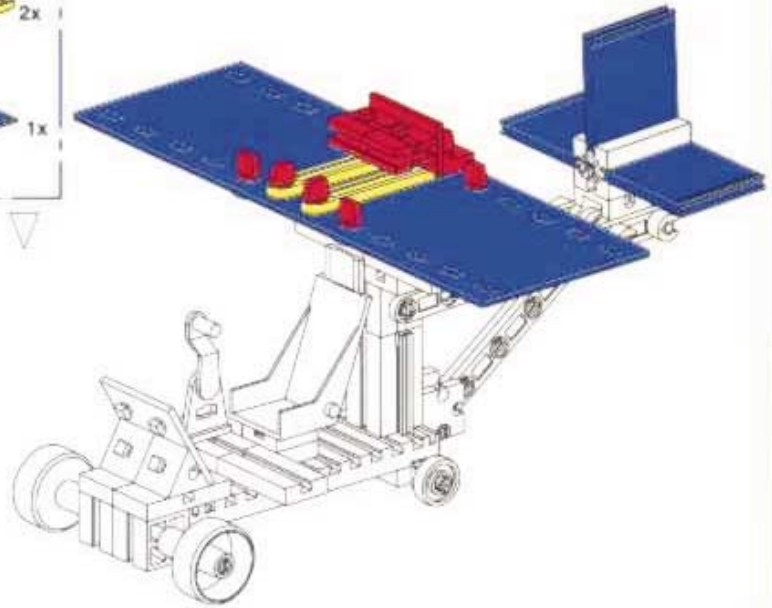
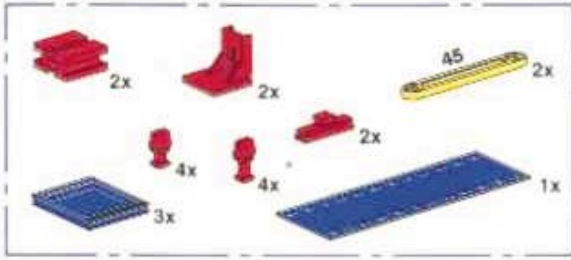

6

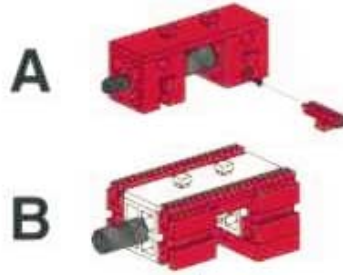
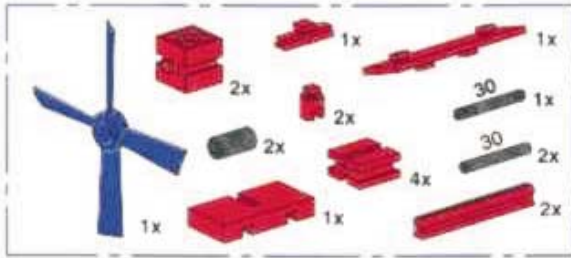

Seite 22  
 Page 22  
 Page 22  
 Bladzijde 22  
 Página 22  
 Pagina 22

30mm

Schulflugzeug  
Trainig aircraft  
Avion-école

Lesvliegtuig  
Avión para enseñanza  
Velivolo per addestramento

1

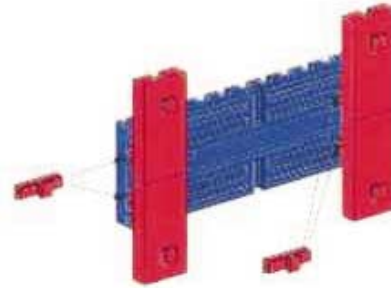

2

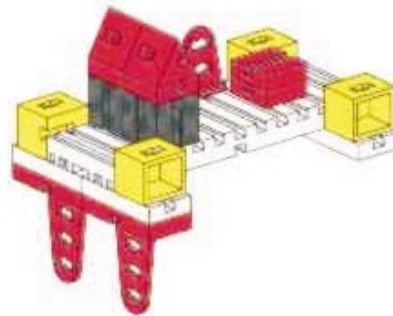
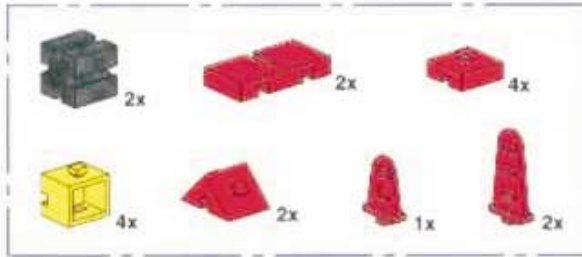

3

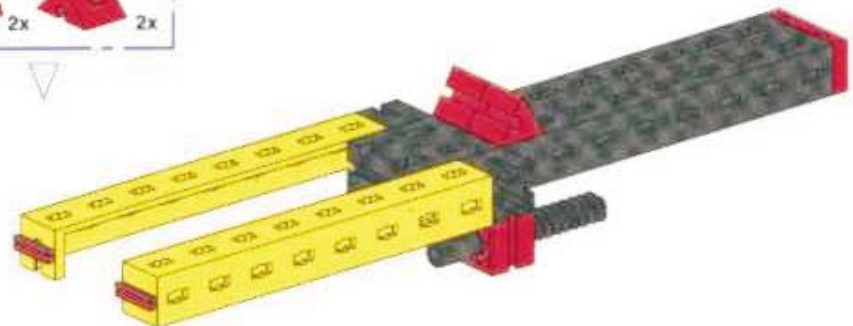
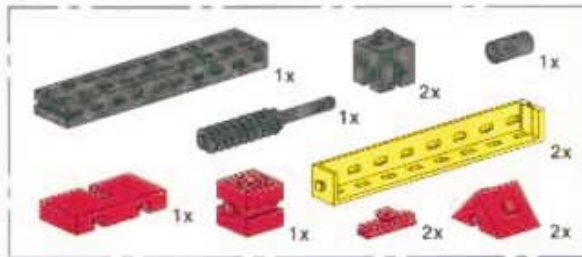

4

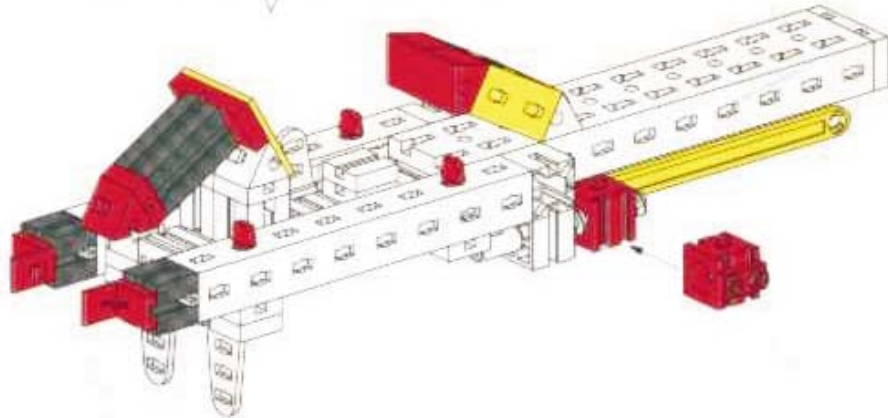
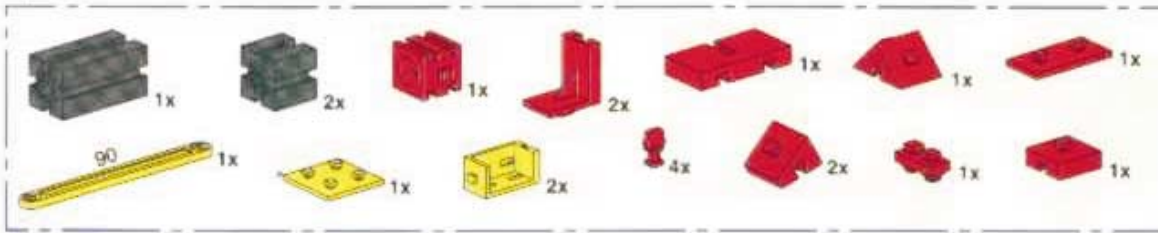

5

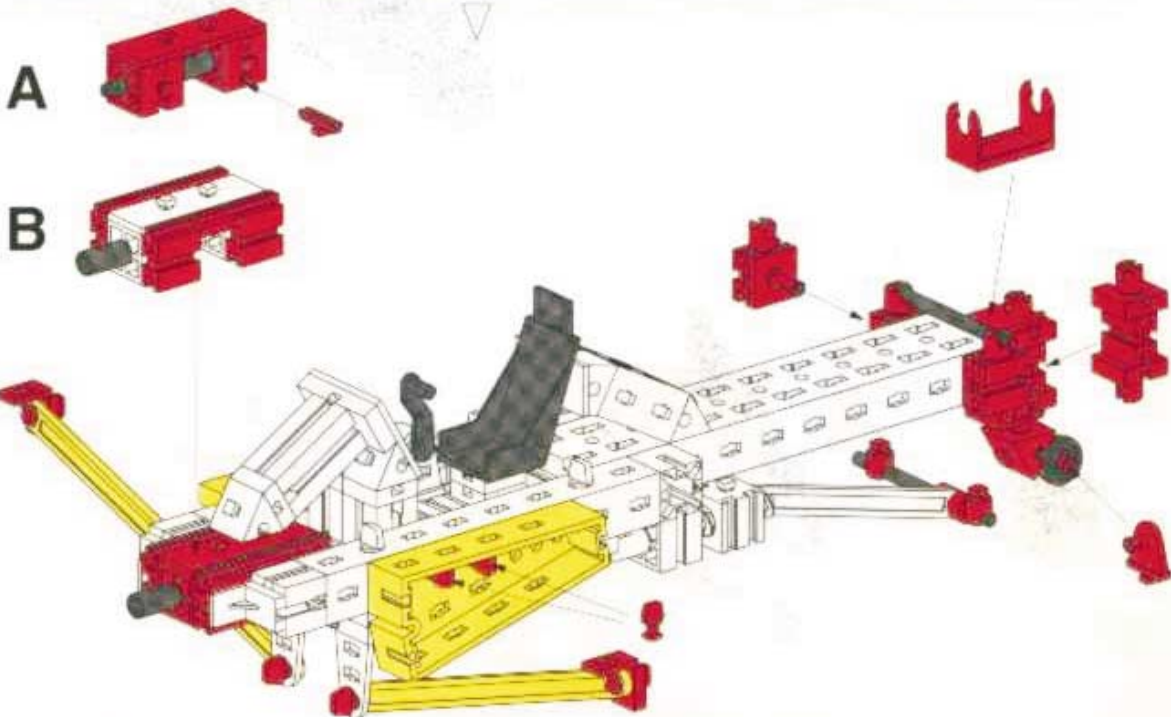
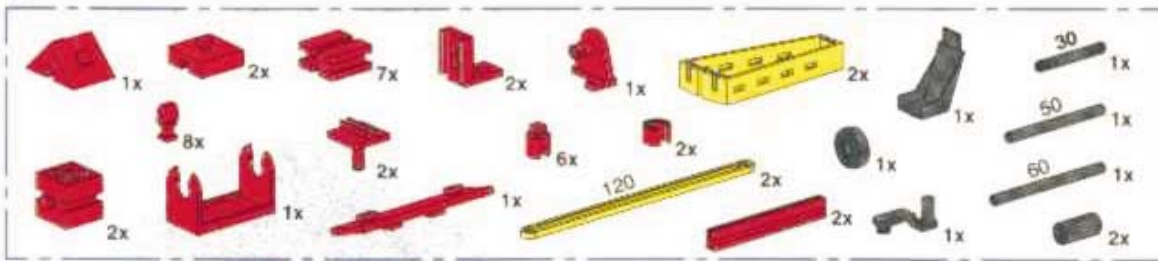

30mm 50mm 60mm



6

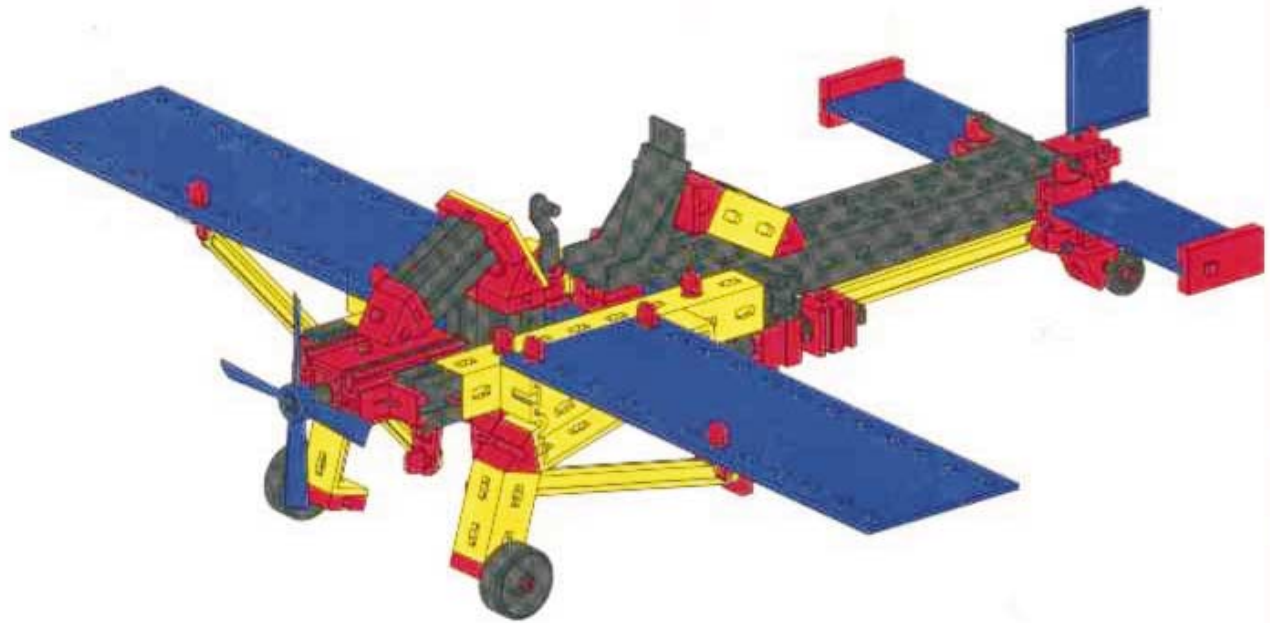
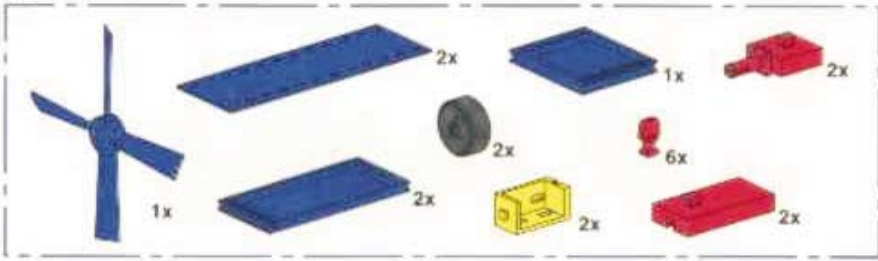

Seite 22  
Page 22  
Page 22  
Bladzijde 22  
Página 22  
Pagina 22

Flugzeug mit Tower  
 Aircraft with tower  
 Avion avec tor de contrôle

Vliegtuig met verkeerstoren  
 Aeroplano con torre  
 Aeroplano con tower

1

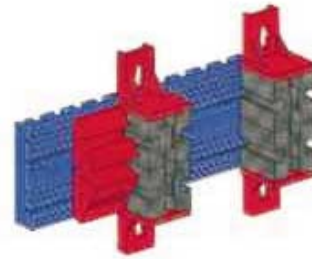
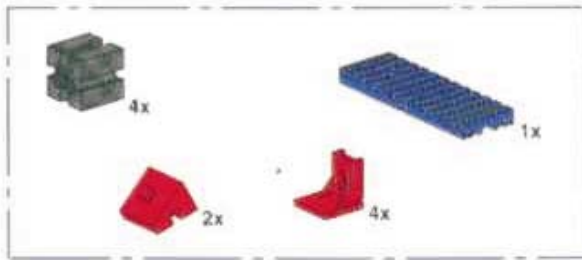

2

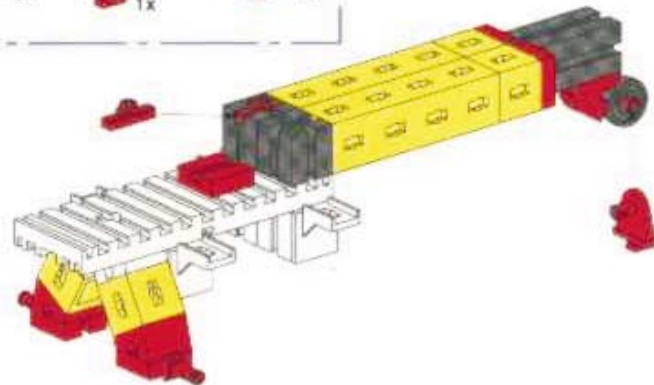
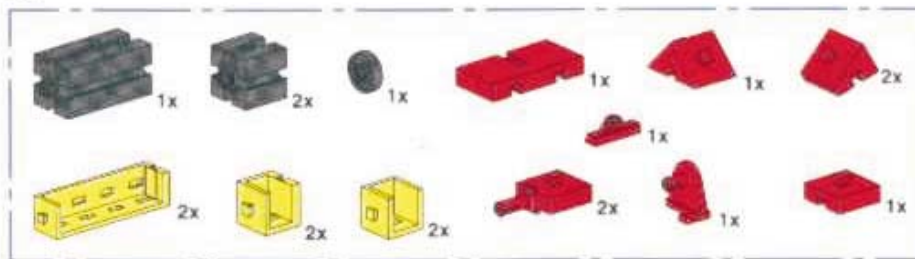

3

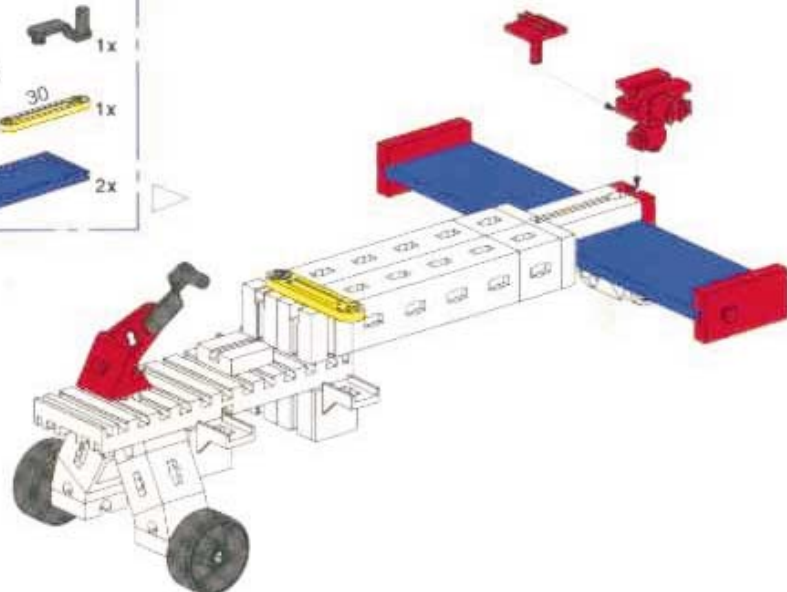
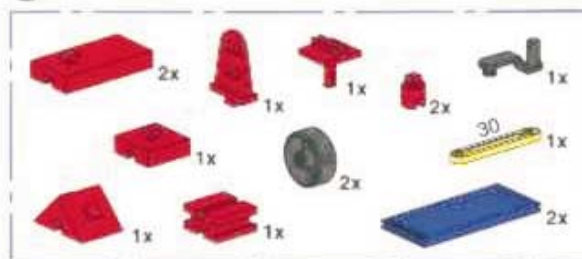

# 4

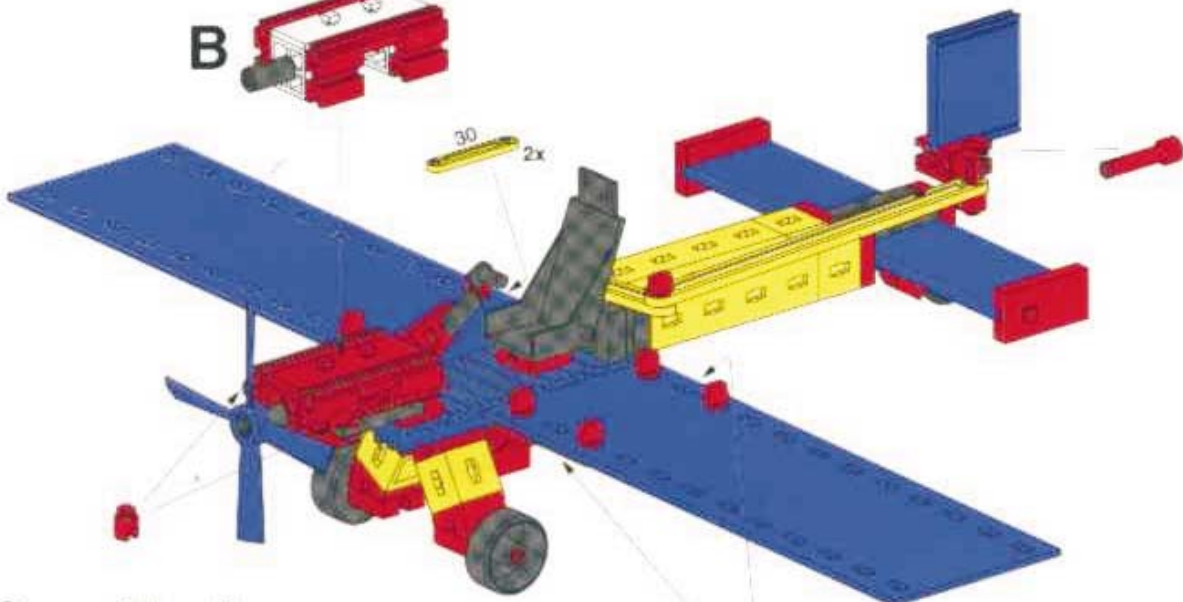
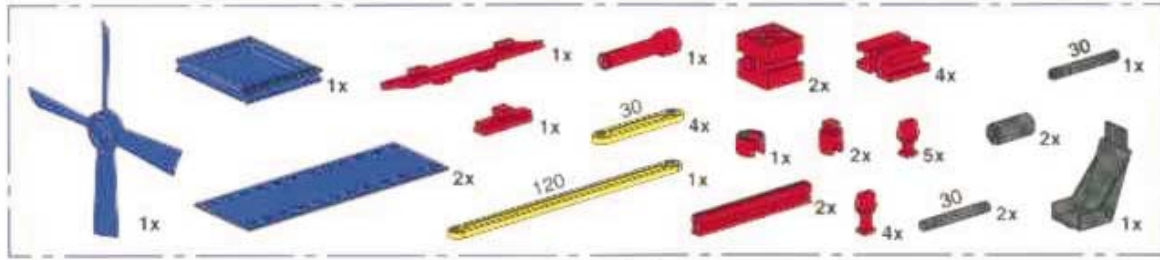

Seite 23  
Page 23  
Page 23  
Bladzijde 23  
Página 23  
Pagina 23

# 5

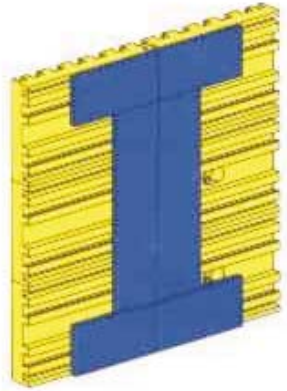
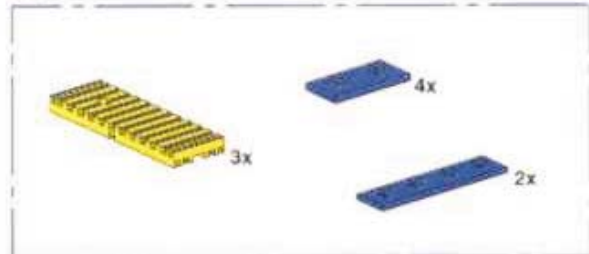

30mm

6

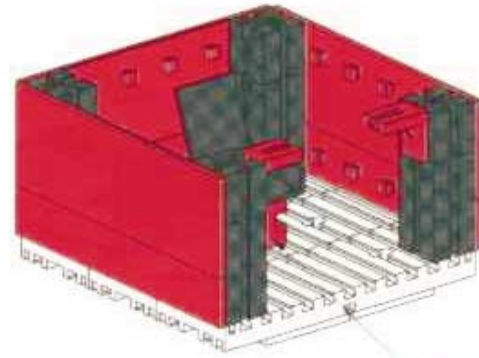
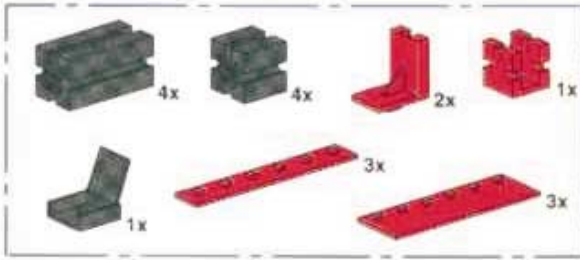

7

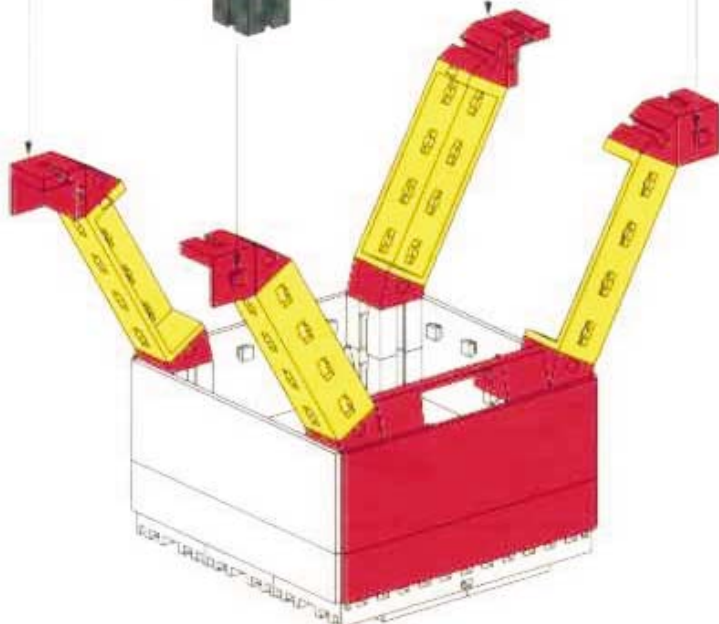
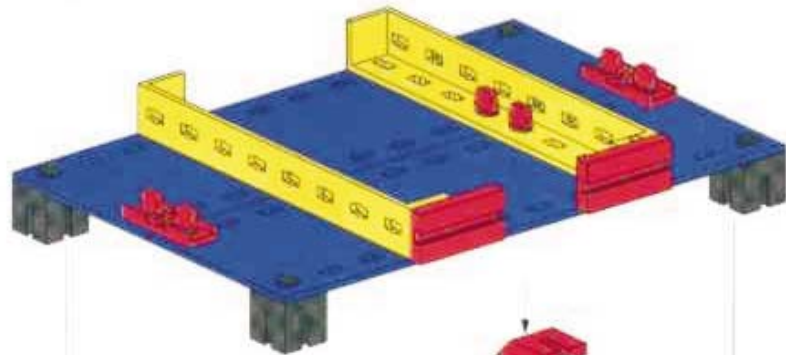
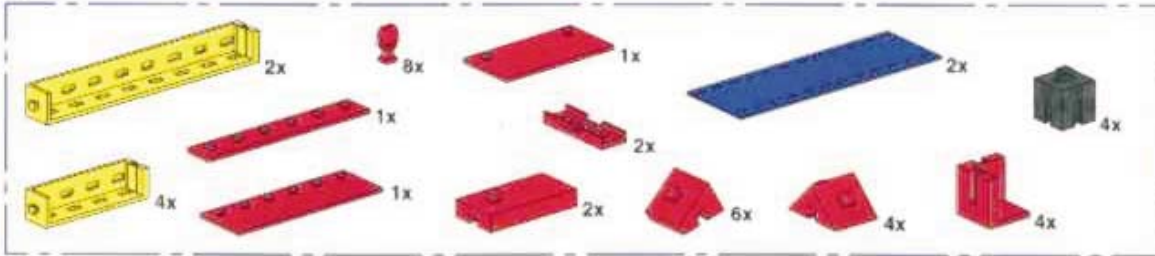

# 8

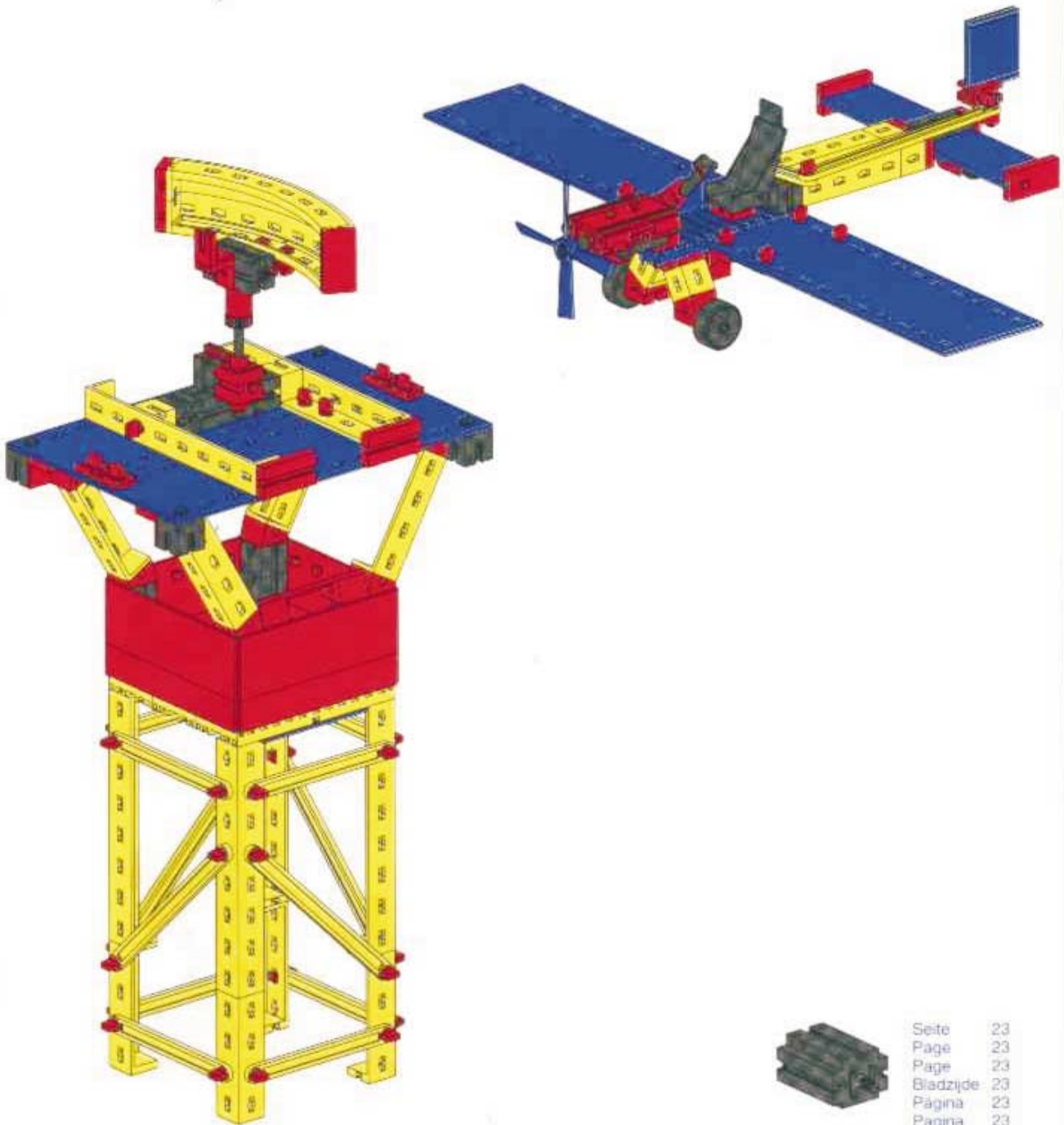
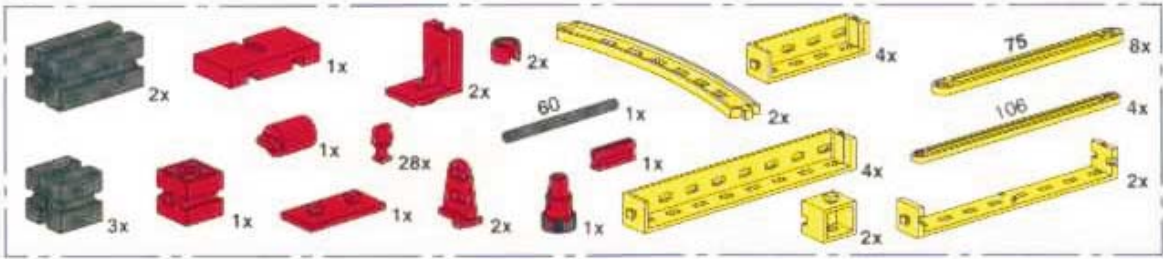

Seite 23  
 Page 23  
 Page 23  
 Bladzijde 23  
 Pàgina 23  
 Pagina 23

60mm

Wasserflugzeug  
Seaplane  
Hidroplano

Watervliegtuig  
Idrovolanto  
Hydravion

1

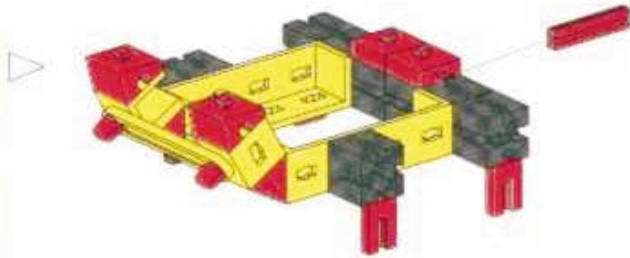
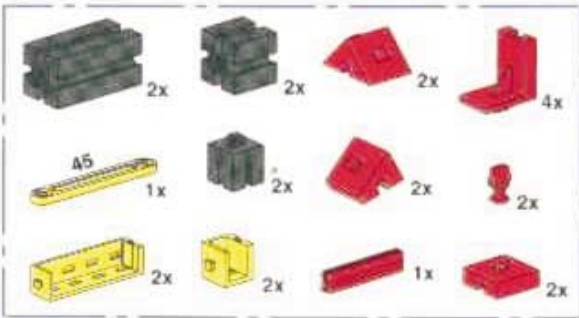

2

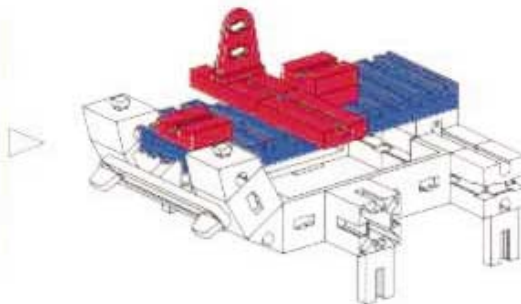
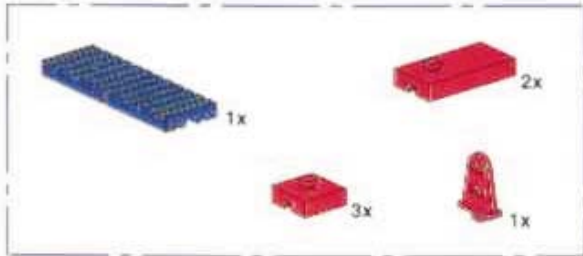

3

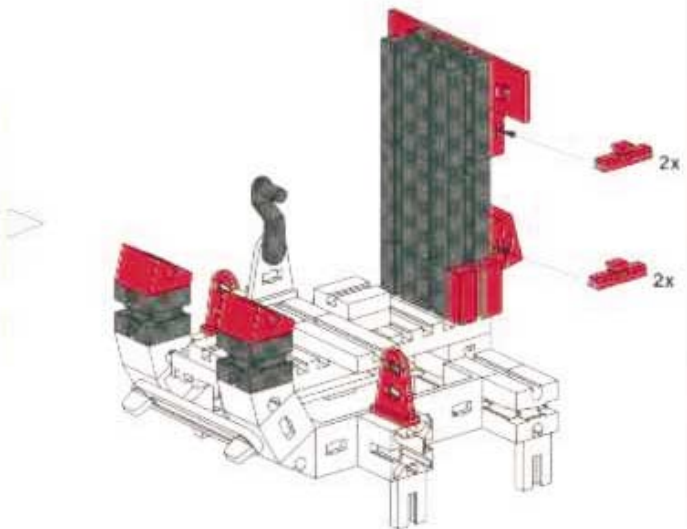
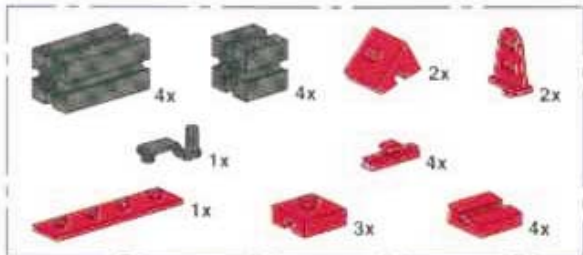

4

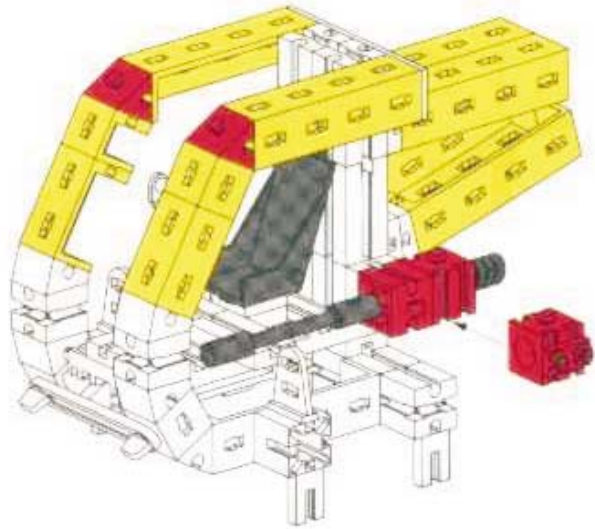
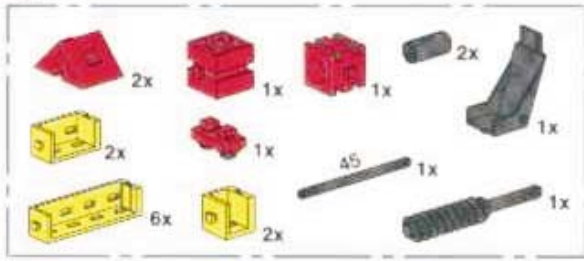

5

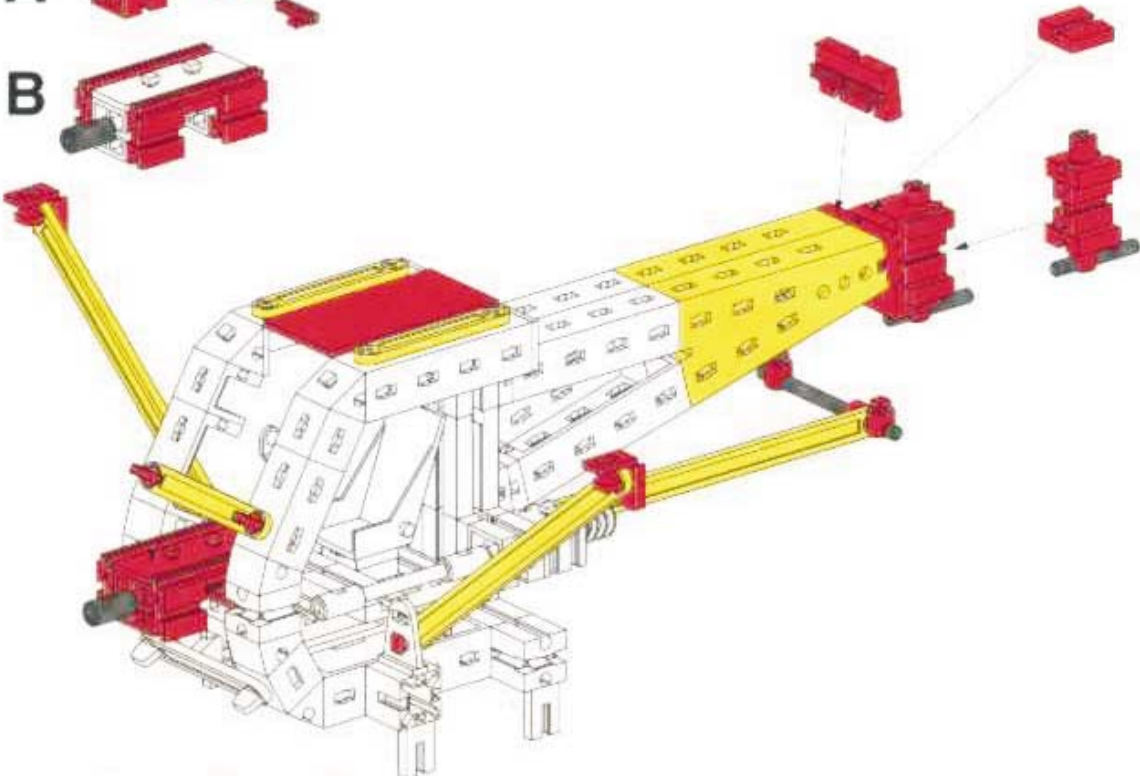
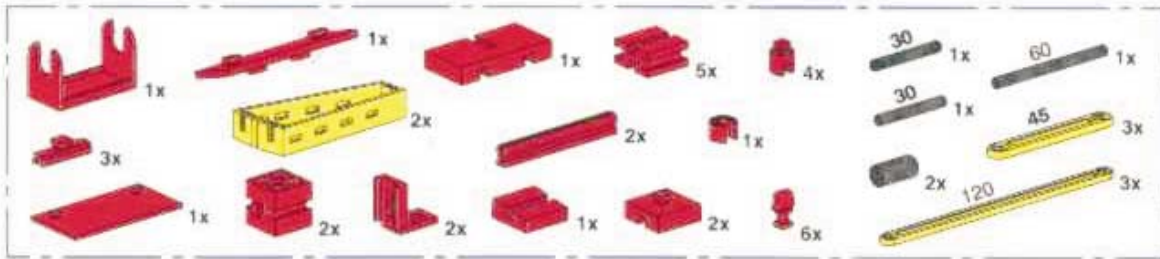

30mm 45mm 60mm

6

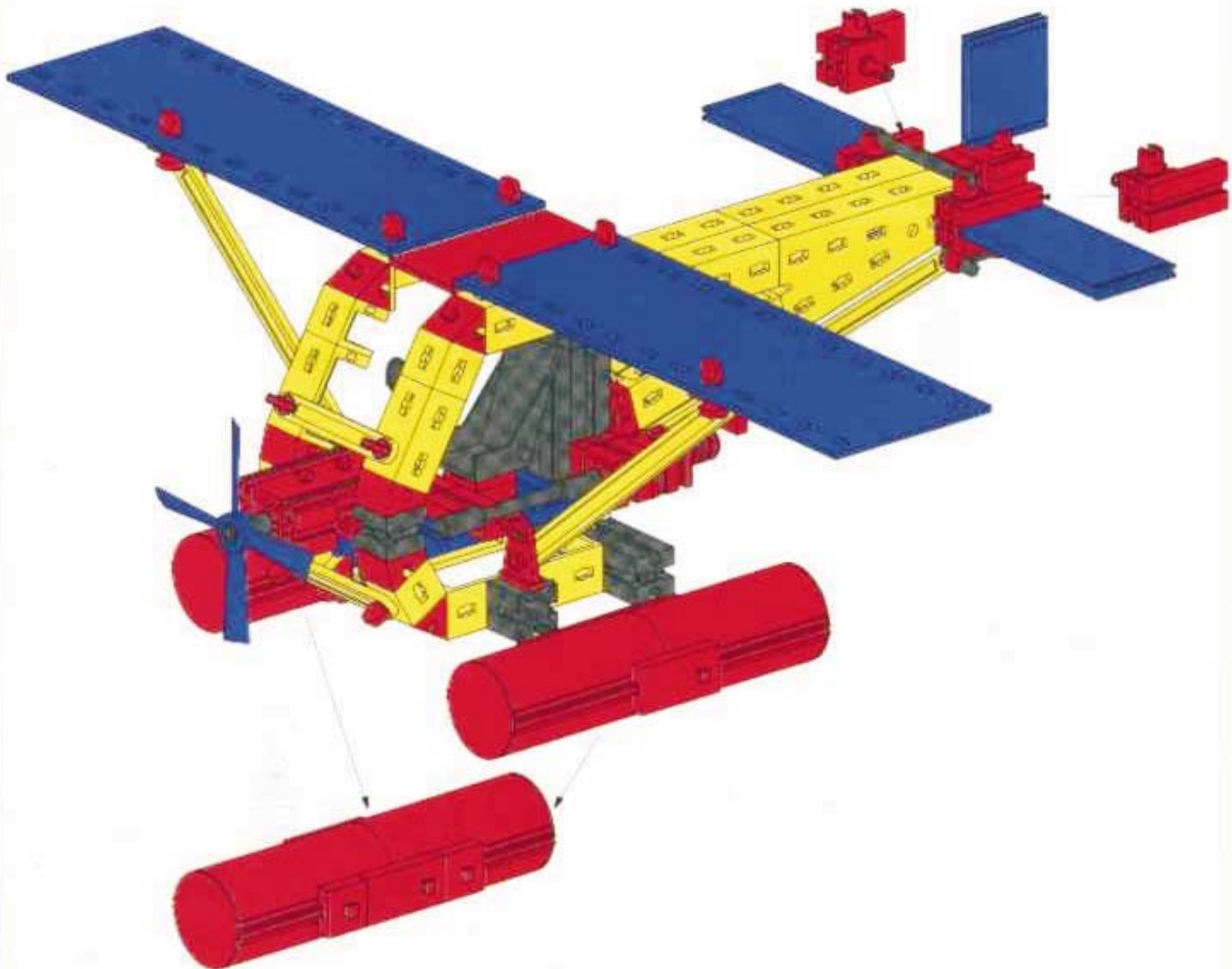
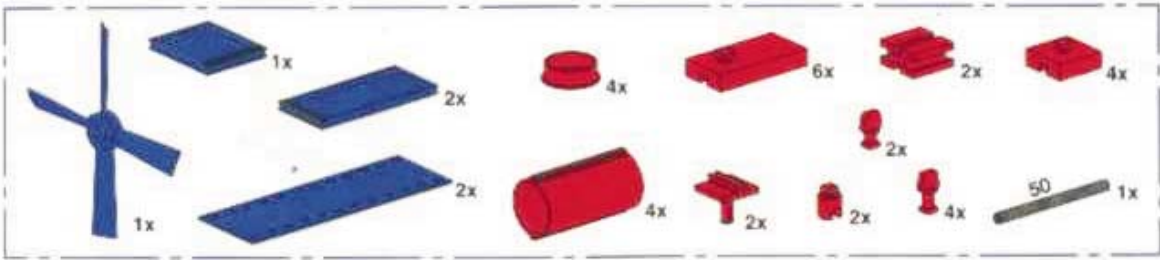

Seite 24  
 Page 24  
 Page 24  
 Bladzijde 24  
 Página 24  
 Pagina 24

50mm



# Piper Alpha

1

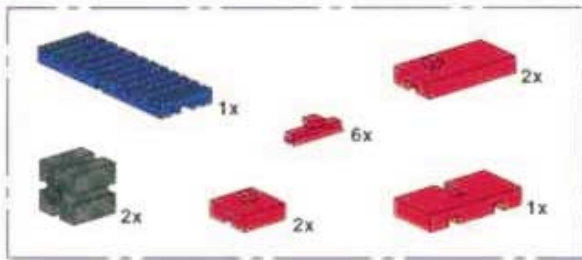

2

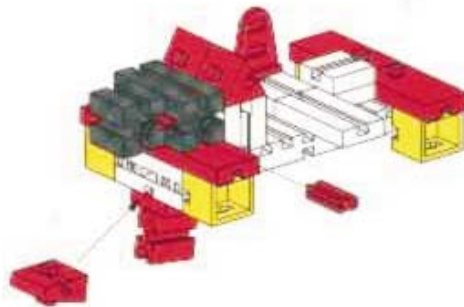
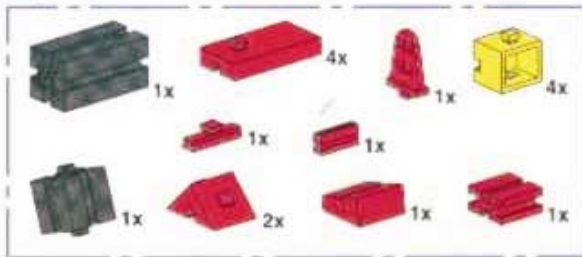

3

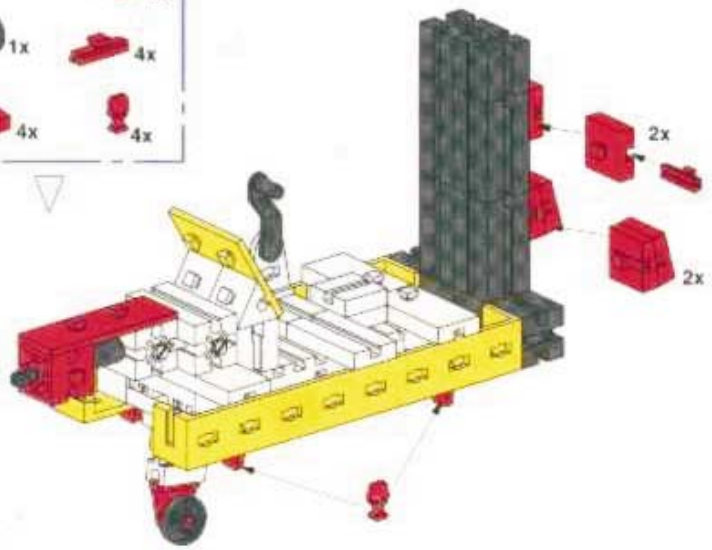
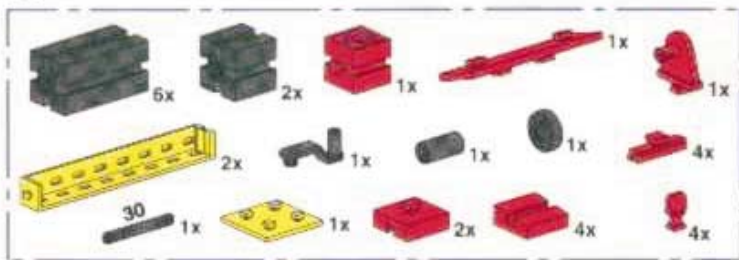

30mm

4

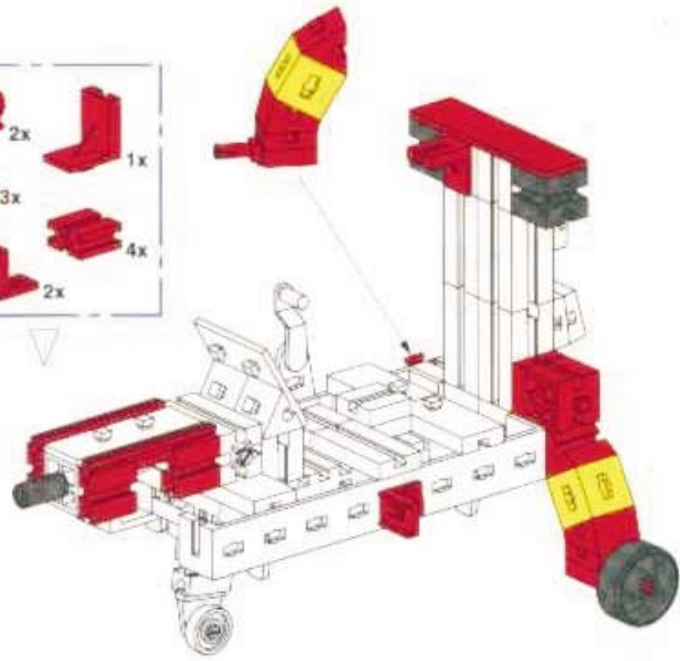
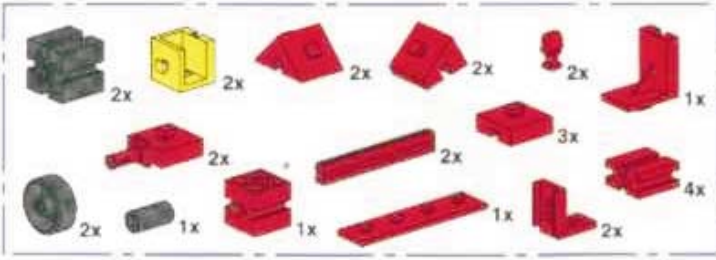

5

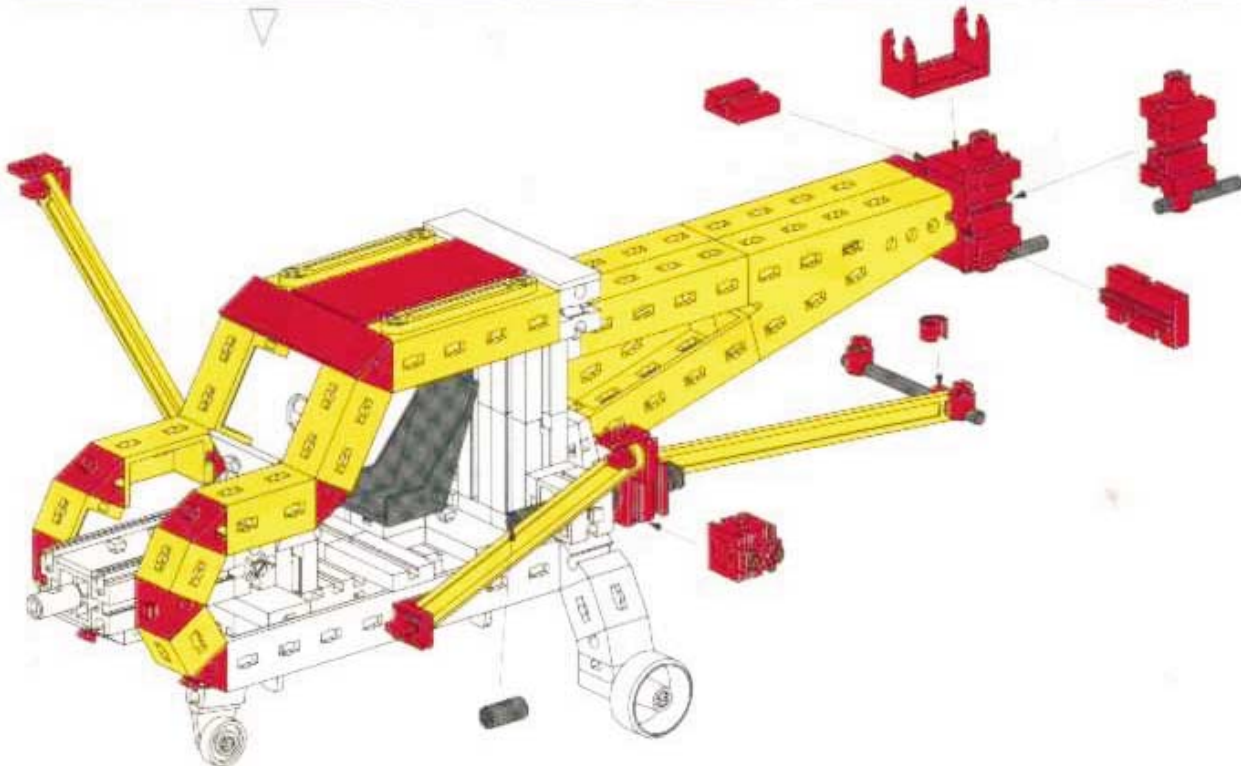
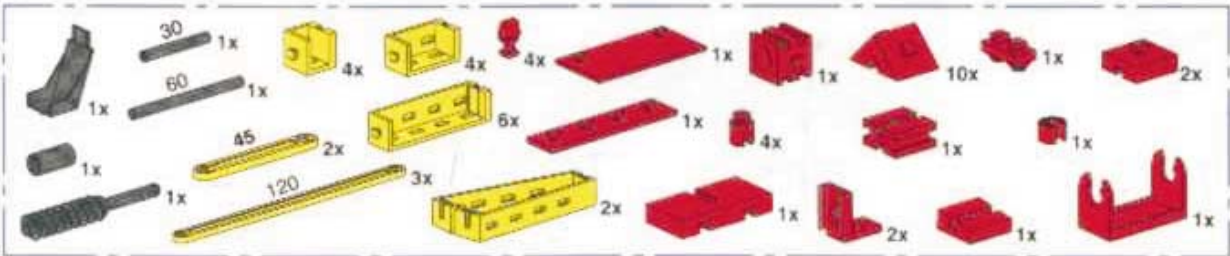

30mm

60mm

# 6

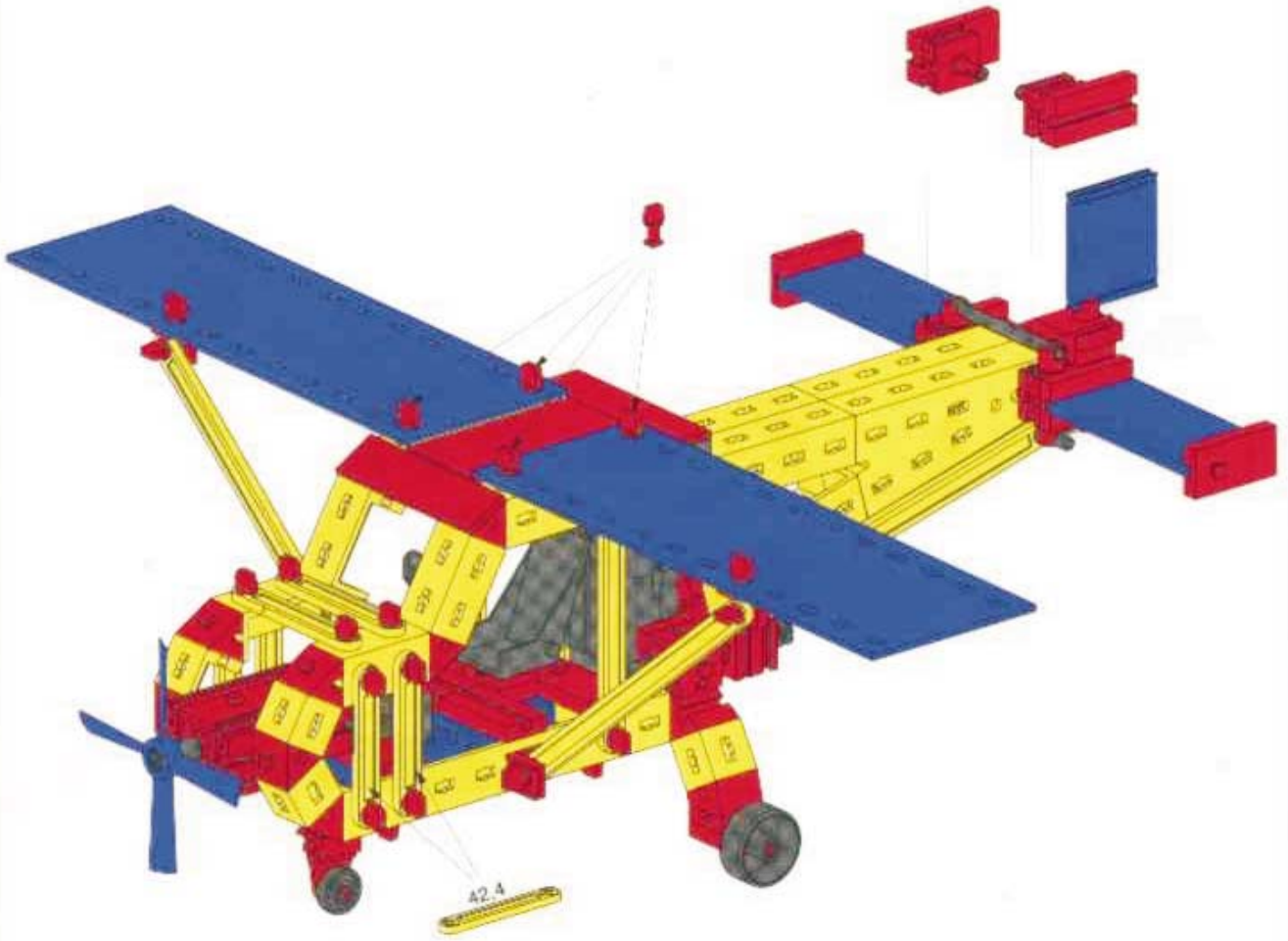
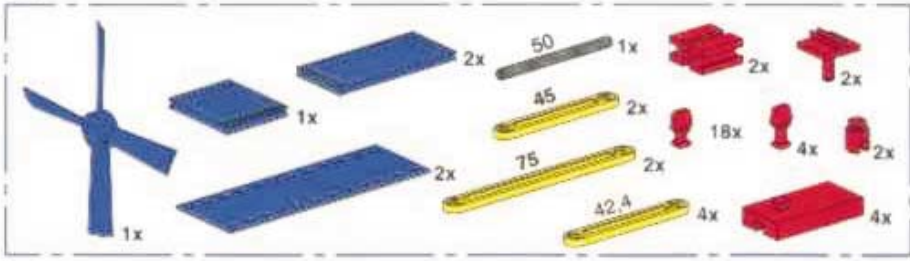

Seite 25  
 Page 25  
 Page 25  
 Bladzijde 25  
 Pagina 25  
 Pagina 25

50mm

Doppeldecker  
Biplane  
Biplano

Tweedekker  
Biplano  
Biplan

1

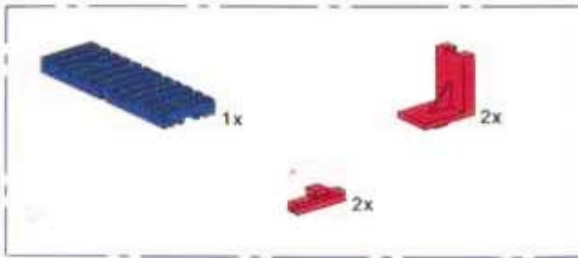

2

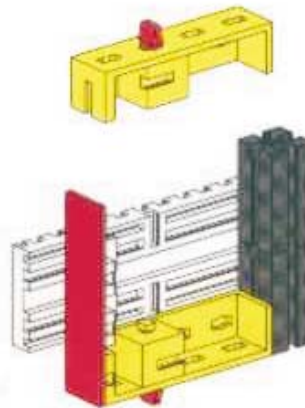
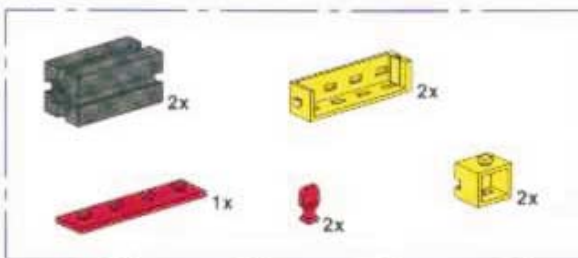

3

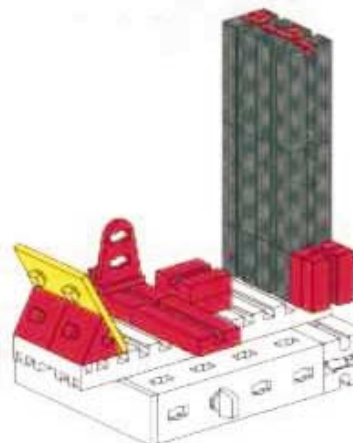
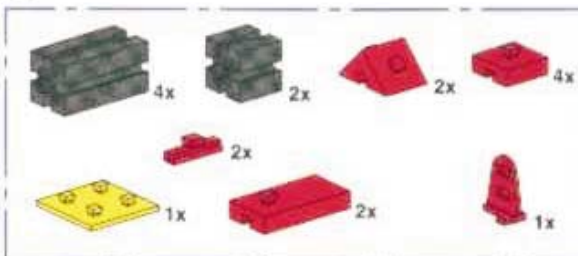

4

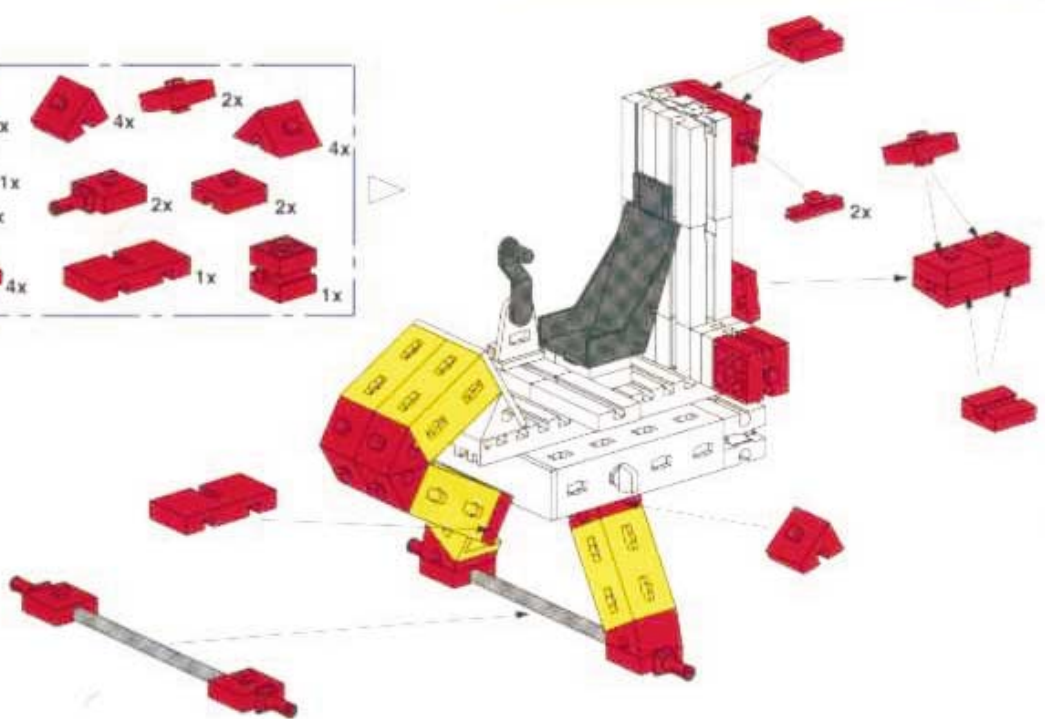
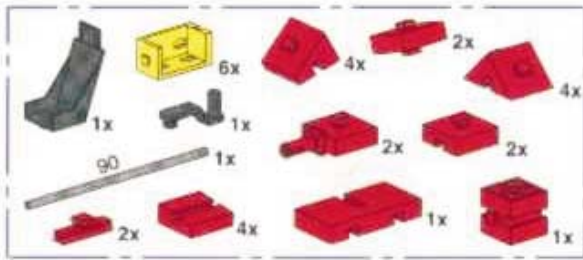

5

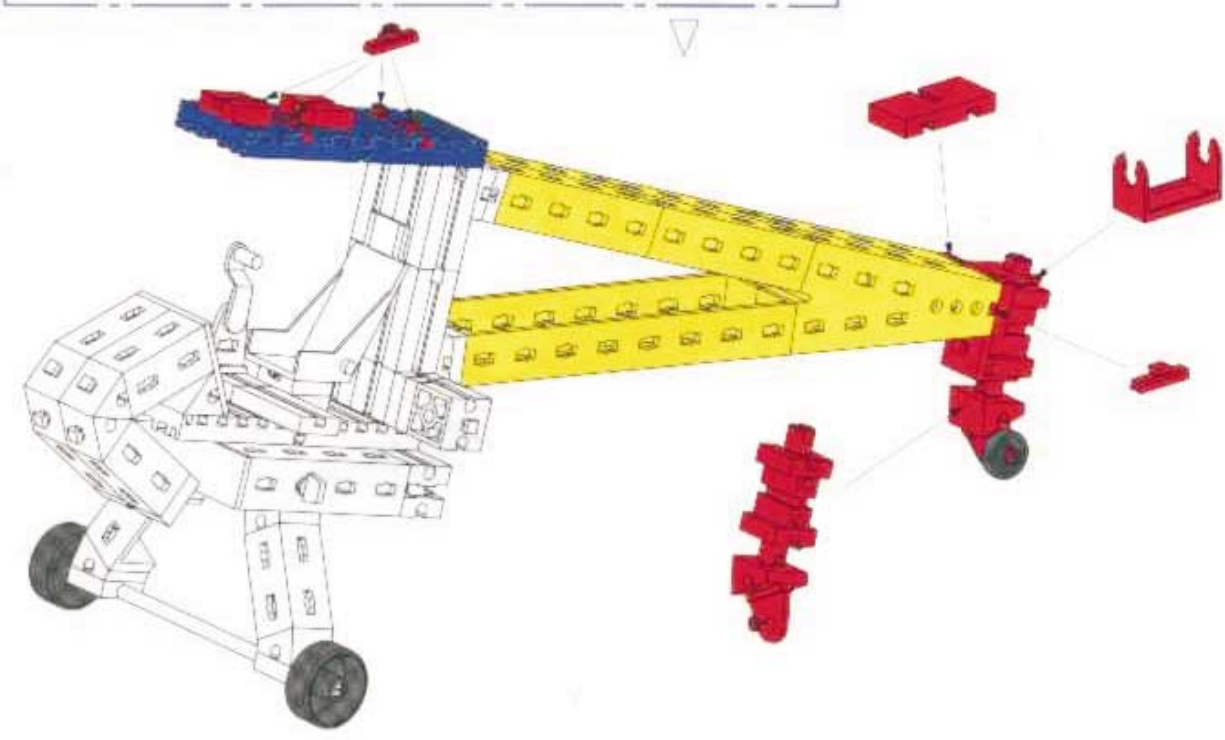
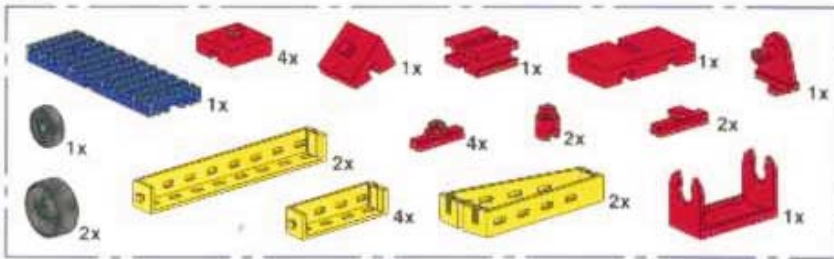

90mm

6

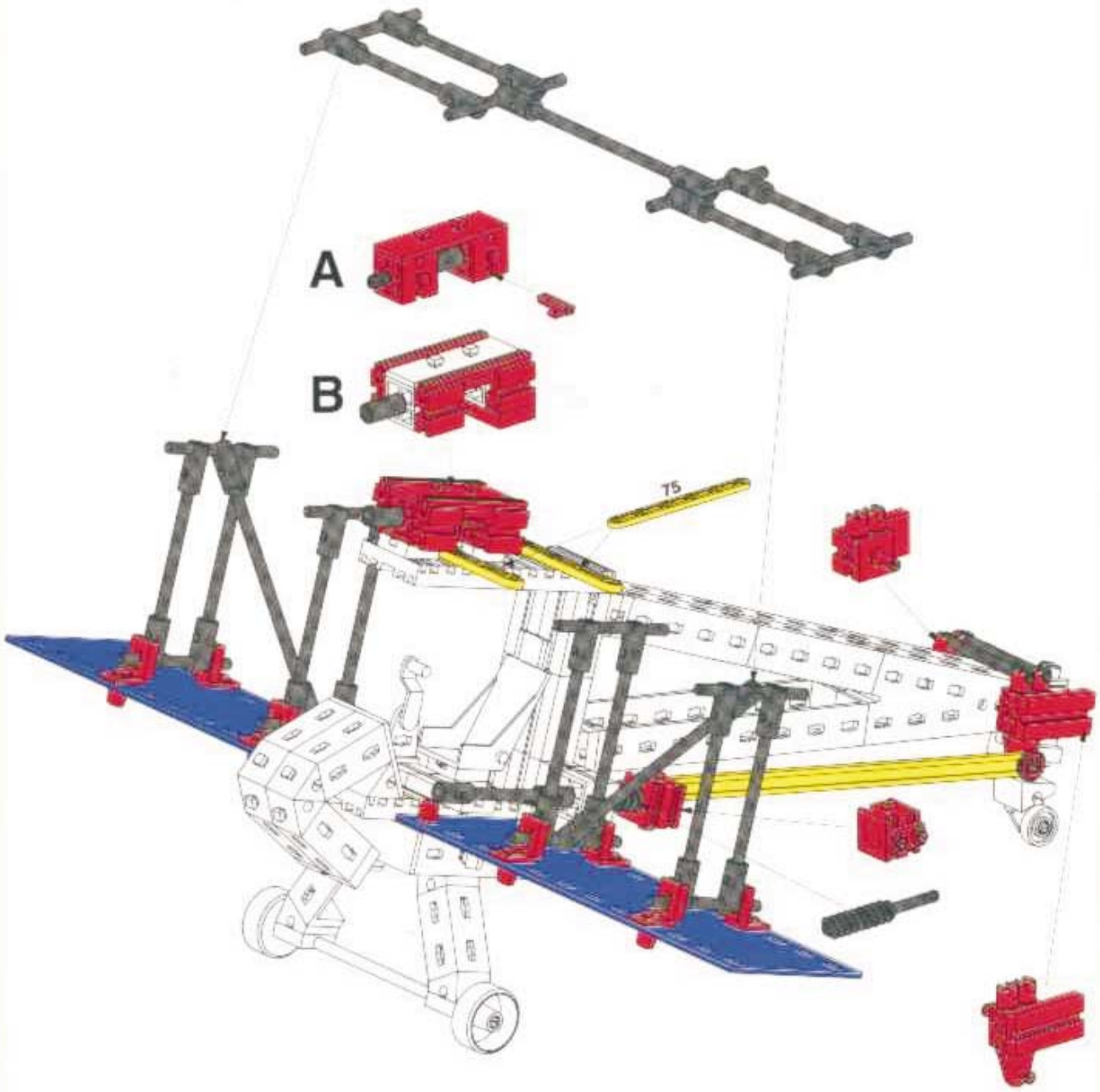
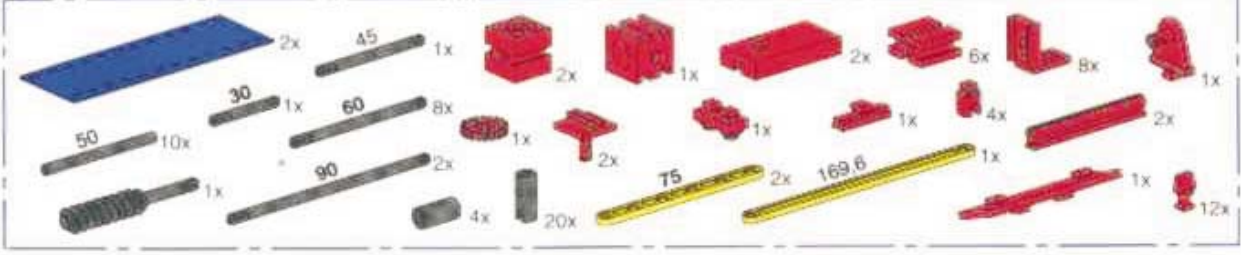

30mm 45mm 50mm 60mm 90mm

7

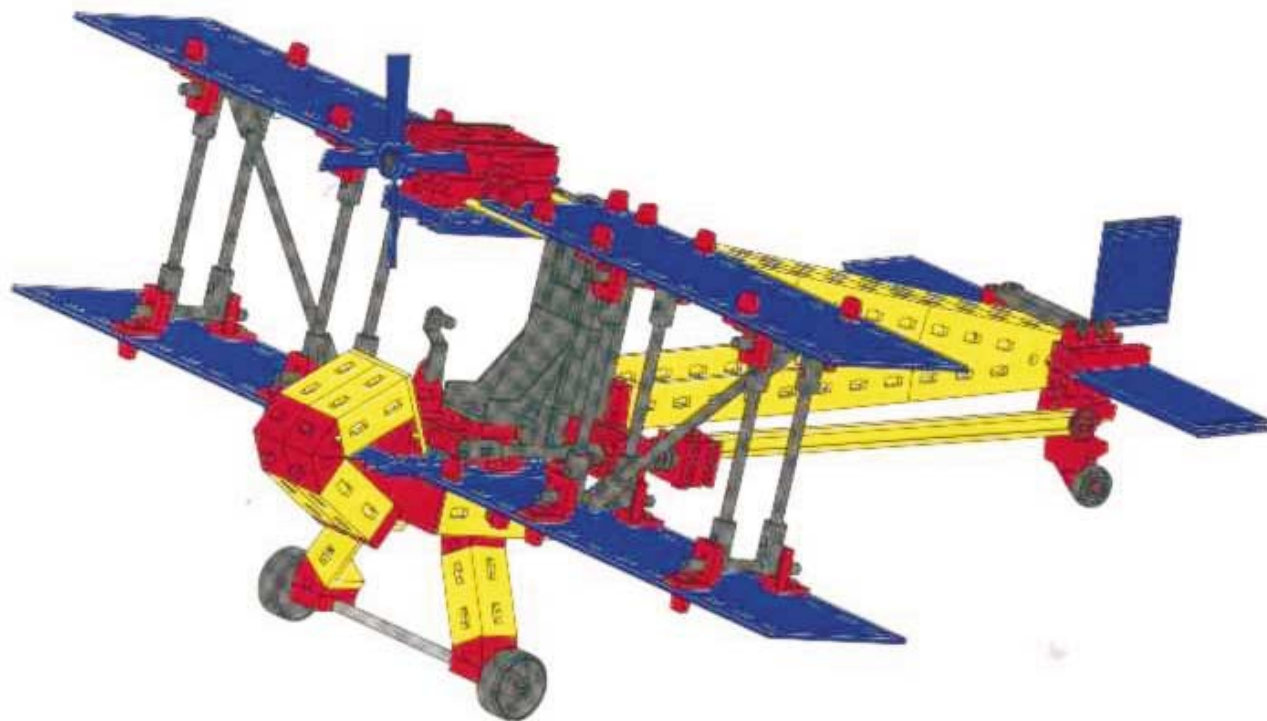
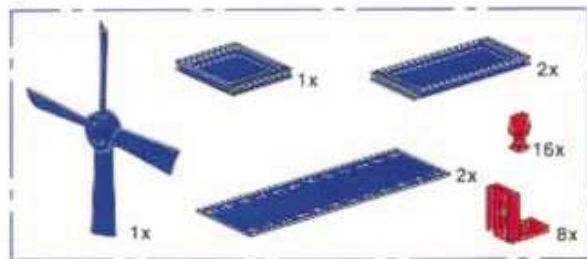

Sete 26  
 Page 26  
 Page 26  
 Bladzijde 26  
 Pagina 26  
 Pagina 26

Motorisierung  
Motor unit  
Motorisation

Motorisring  
Motorización  
Motorizzazione

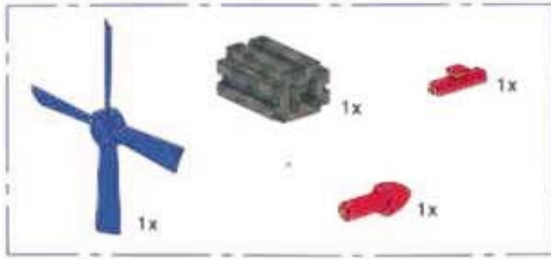

mit - with - avec  
met - con - con

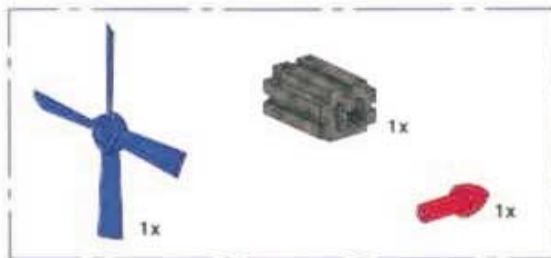
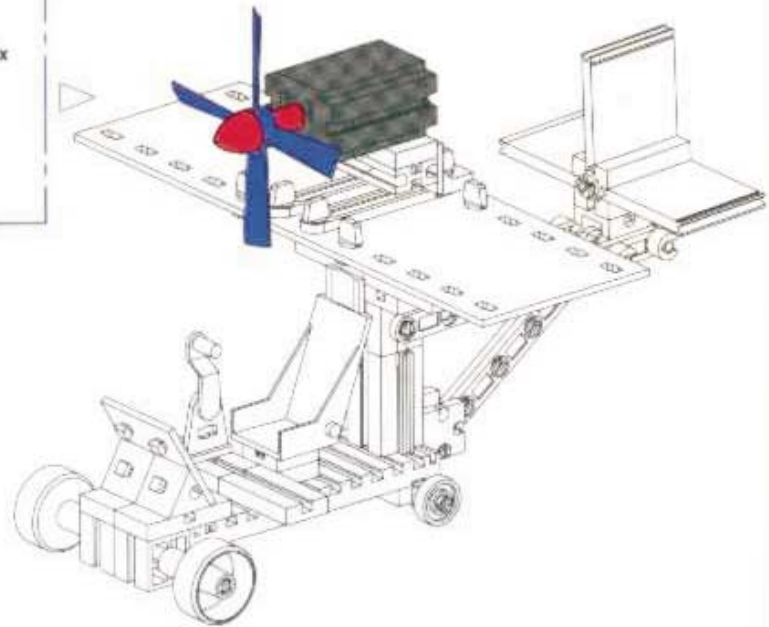
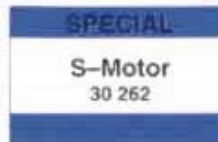

mit - with - avec  
met - con - con

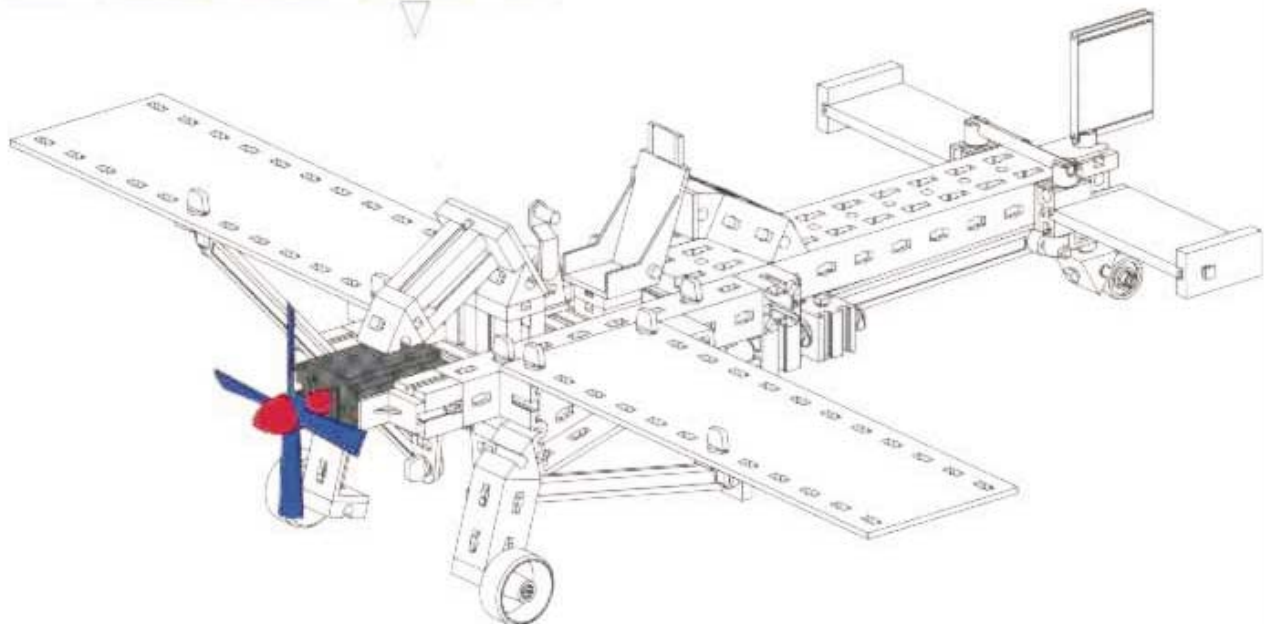
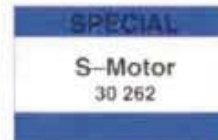



Motorisierung  
 Motor unit  
 Motorisation

Motorisring  
 Motorización  
 Motorizzazione

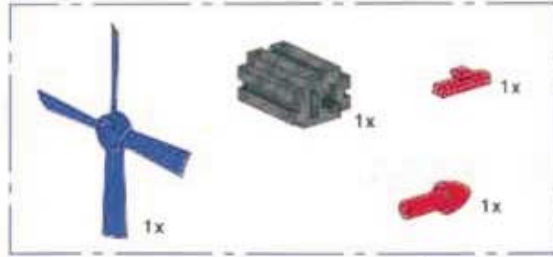

mit – with – avec  
 met – con – con

**SPECIAL**  
**S-Motor**  
 30 262

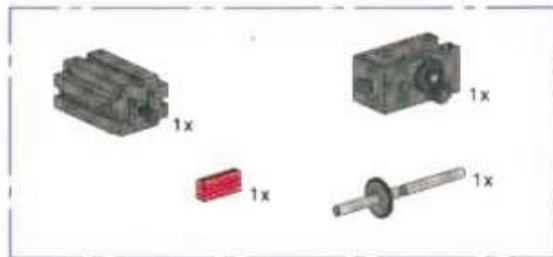
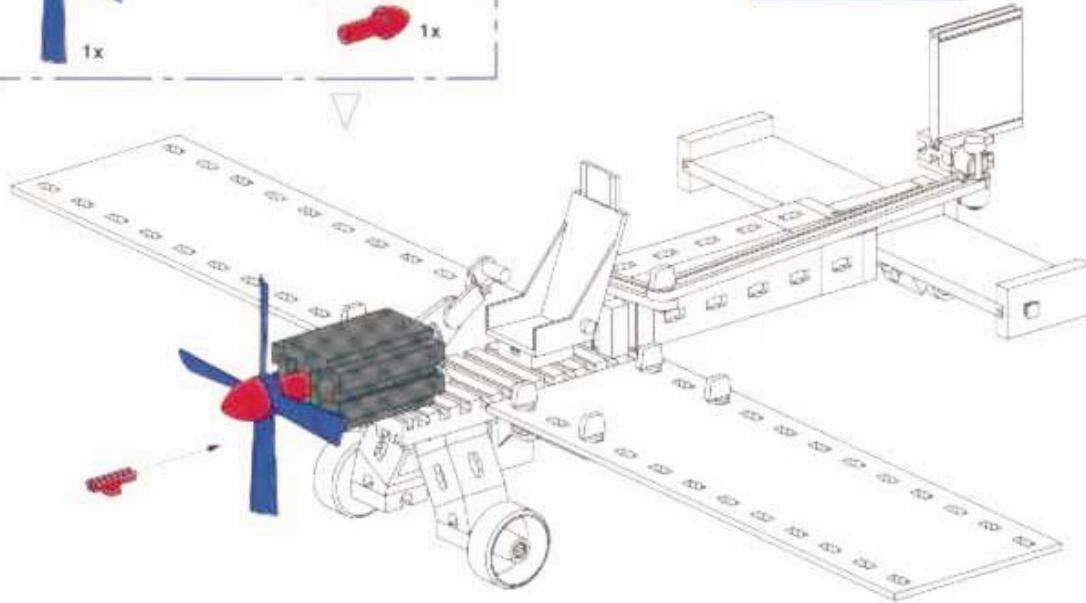

mit – with – avec  
 met – con – con

**SPECIAL**  
**S-Motor**  
 30 262

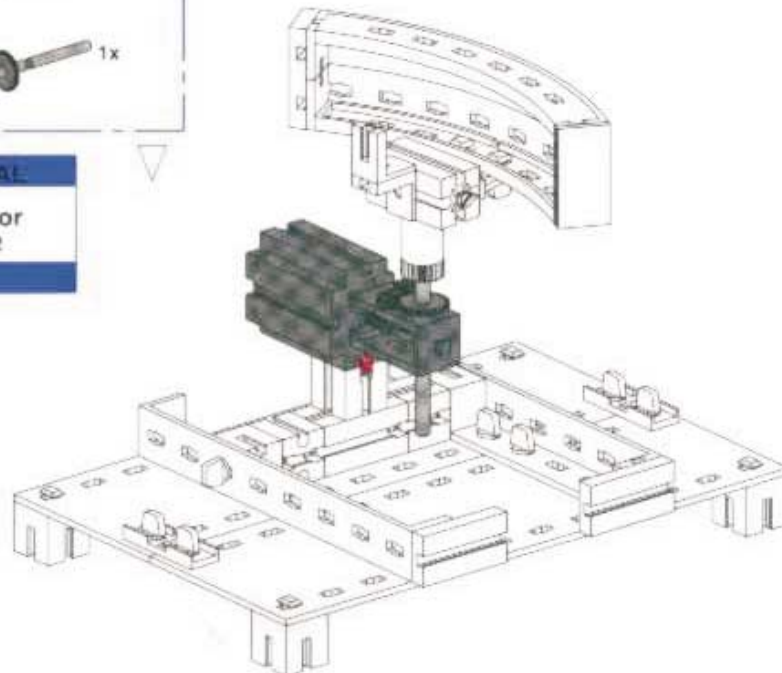

Motorisierung  
Motor unit  
Motorisation

Motorisring  
Motorización  
Motorizzazione

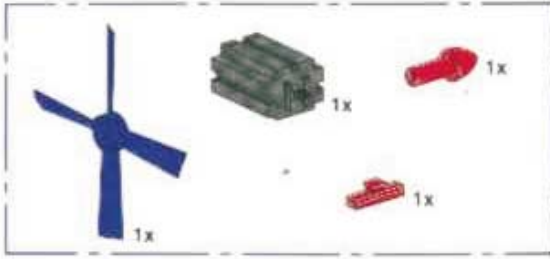

mit – with – avec  
met – con – con

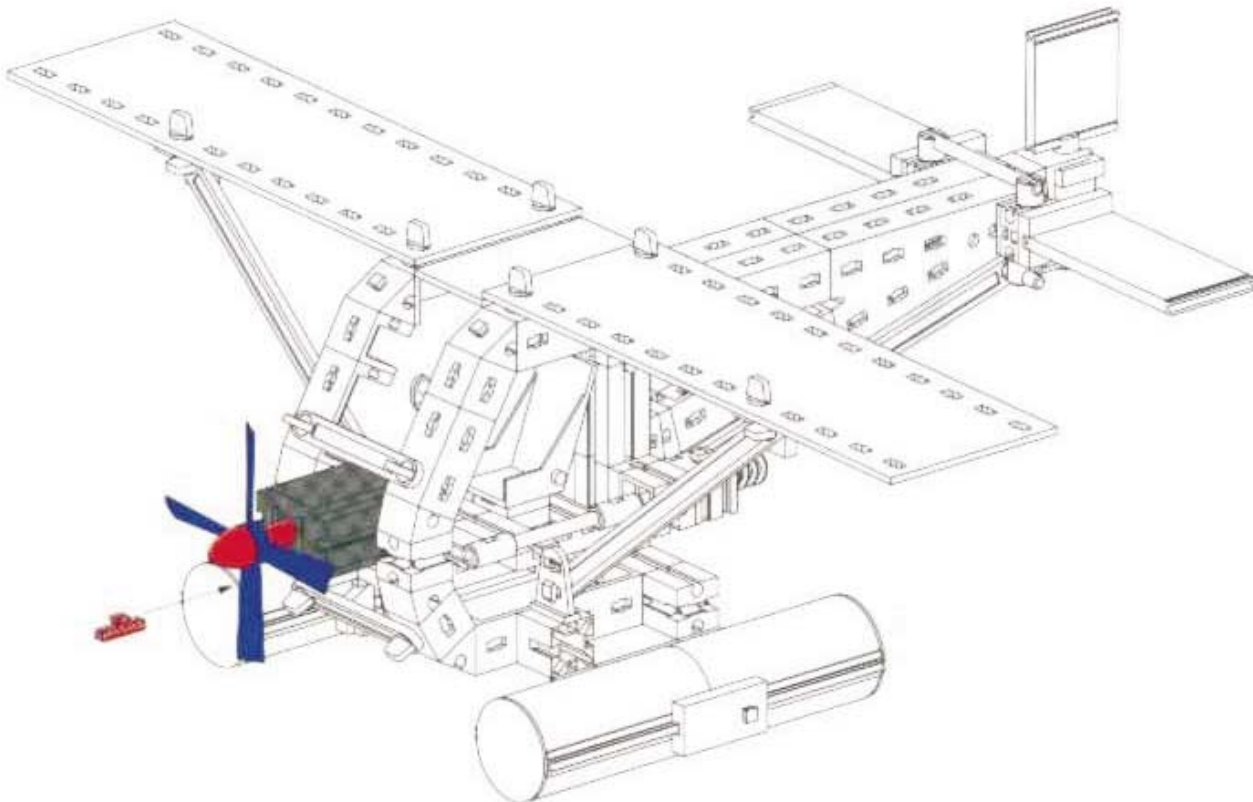
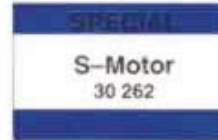

Motorisierung  
 Motor unit  
 Motorisation

Motorisring  
 Motorización  
 Motorizzazione



mit – with – avec  
 met – con – con

**SPECIAL**  
**S-Motor**  
 30 262

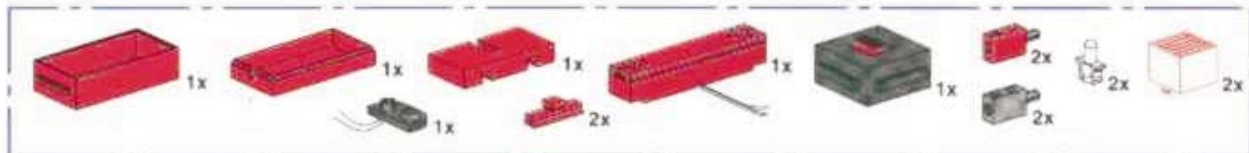
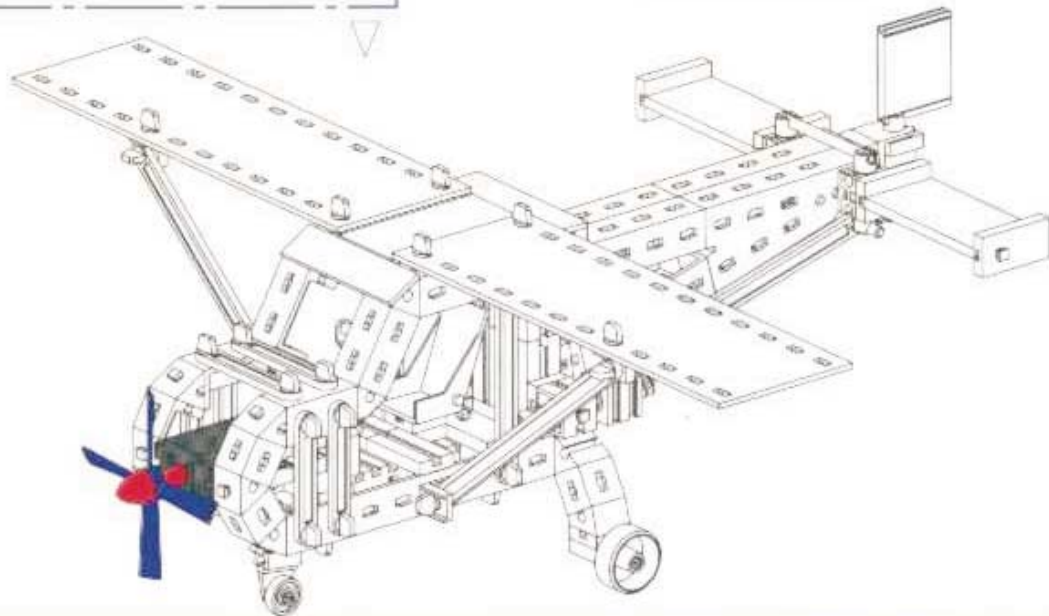

mit – with – avec  
 met – con – con

**MASTER PLUS**  
**Highlights**  
 30 315

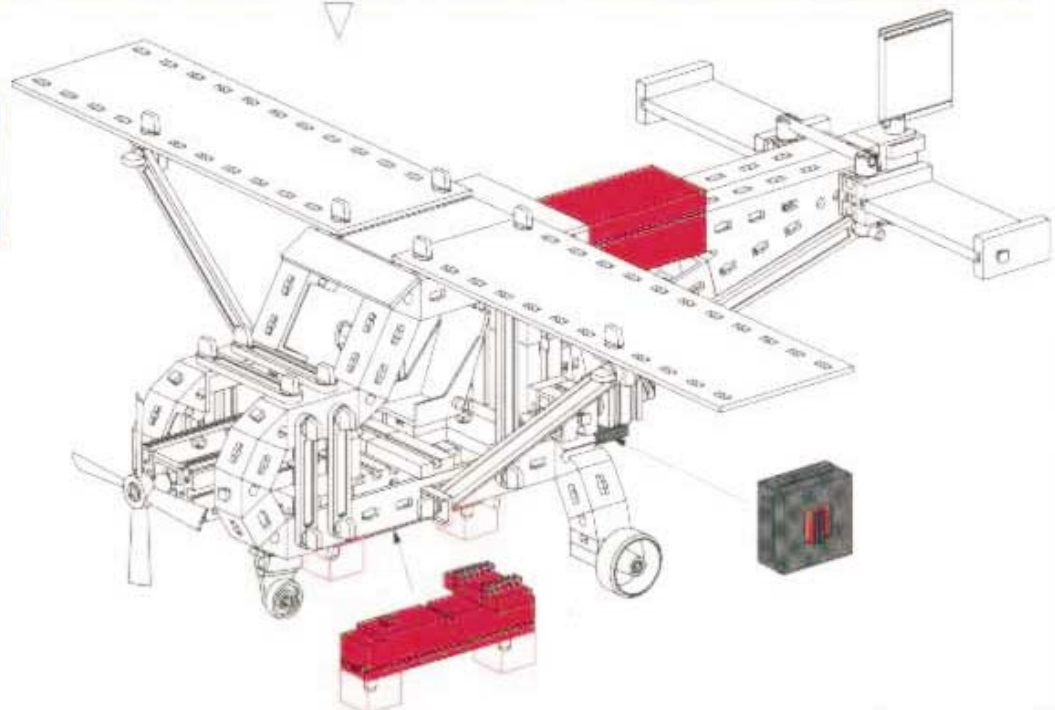



mit - with - avec  
met - con - con

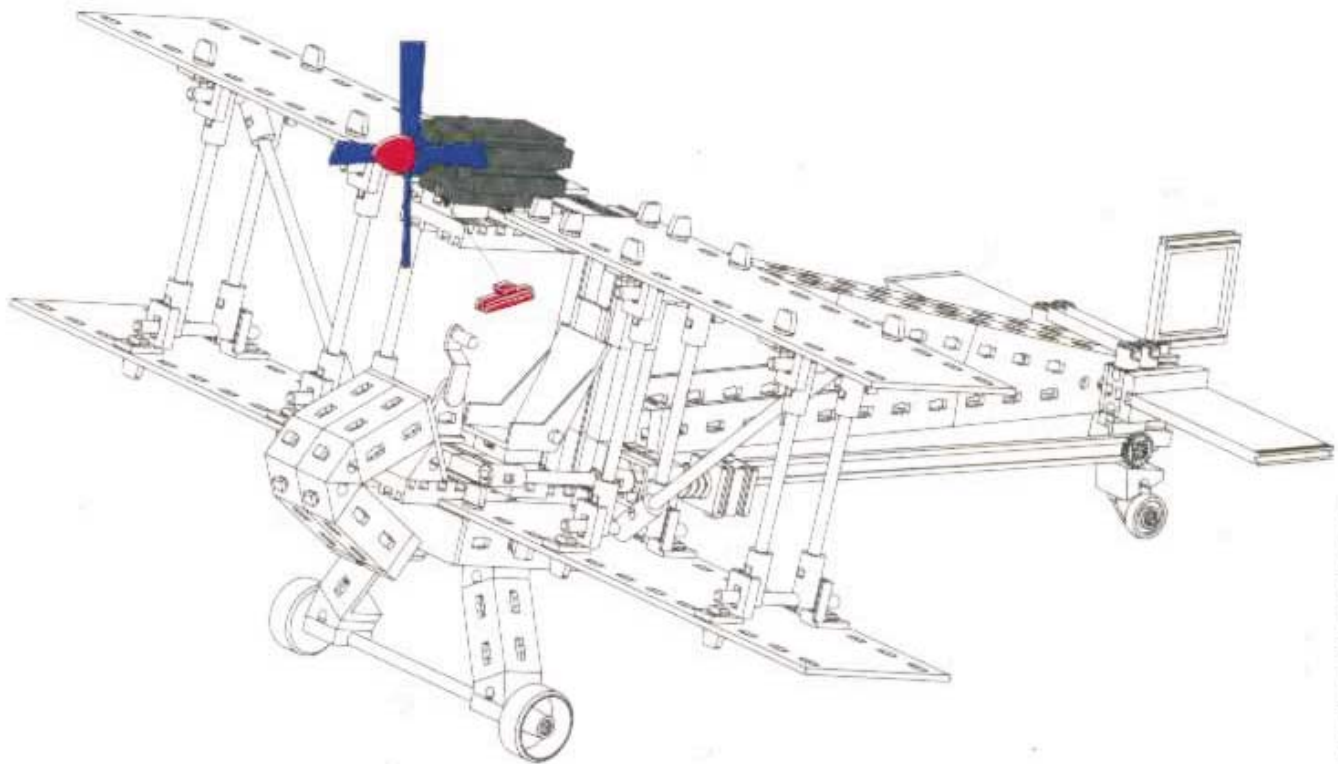

36343 1:2/92 KW - invented in Germany  
Technische Änderungen vorbehalten. Subject to technical modifications.